



RHINO-RACK

RVP64 Supplement - Mitsubishi Lancer Sedan 07 - 17.

Important: Please read these instructions carefully prior to installation.
 Please refer to your fitting instruction to ensure that the Roof Rack System is installed in the correct location.
 Check the contents of kit before commencing fitment and report any discrepancies.
 Place these instructions in the vehicle's glove box after installation is complete.

Maximum load carrying capacity: 75kg/ 165lbs - 2 crossbars

Leg kit: RVL4
Front bar: 919mm
Rear bar: 887mm
Base kit: RCP46-BK
Mount Kit: RDM01



Leg kit: RCL4
VA Bar: VA118S/B
Base kit: RCP46-BK
Mount Kit: RDM01

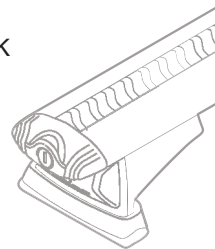

Leg kit: RCL4
HD Bar: RB1120S/B
Spacers: QMHD05
Base kit: RCP46-BK
Mount Kit: RDM01

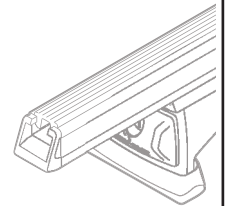

1 Install the RDM01 brackets as per the corresponding instructions (R877).

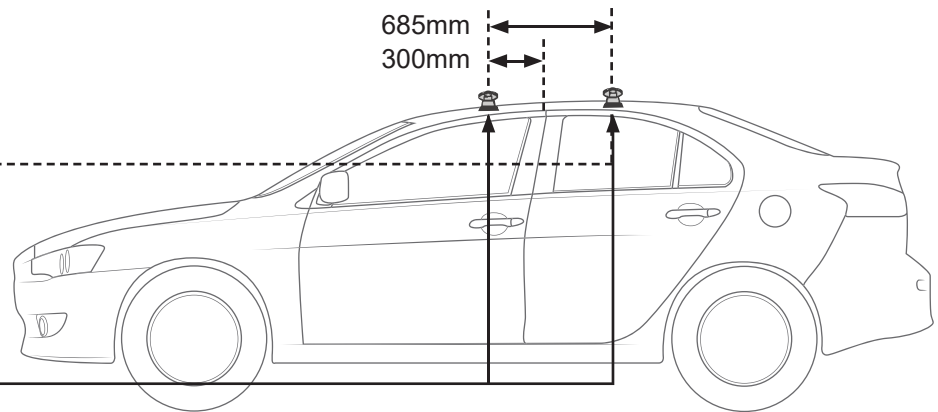
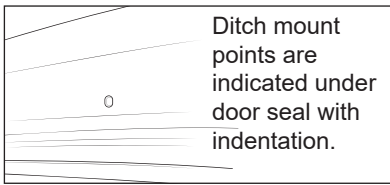
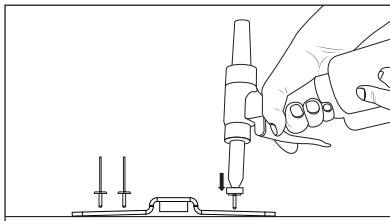

Note Vortex crossbars can be cut to length to fit this vehicle. Measure the desired length out **from the centre of the Vortex Bar** and create a reference with a marker. Carefully cut the bar at these markings using a Saw with an Alloy Cutting Blade.

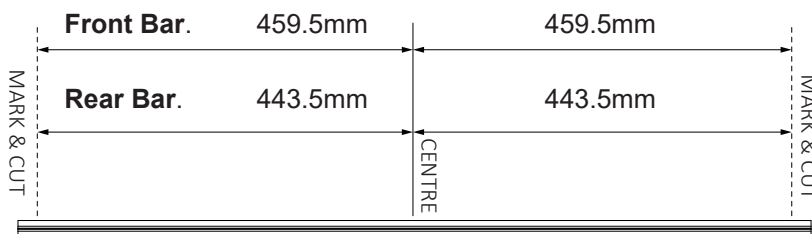

Cut the Bar at the required length.

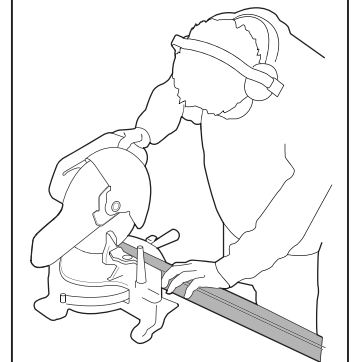

Note for dealers when altering a RSP kits:
 Add 38mm to sports bar measurement for RVL.
 Add 40mm to sports bar measurement for RVH.