

RHINO-RACK®

FORD Ranger P703 **SINGLE Cab Front Bar** Installation RLKVAH

Important:

1. Check the Rhino-Rack website to ensure you have the latest issue of these instructions.
2. Please refer to your fitting instruction to ensure that the roof racks are installed in the correct locations.
3. Check the contents of kit before commencing fitment and report any discrepancies.
4. Place these instructions in the vehicle's glove box after installation is complete.
5. These instructions must be followed for warranty to be upheld.

Fit Time: 1 hour

NOTE: This Fitting Instruction supersedes all instructions when installing 2500 series legs onto the FORD Ranger P703

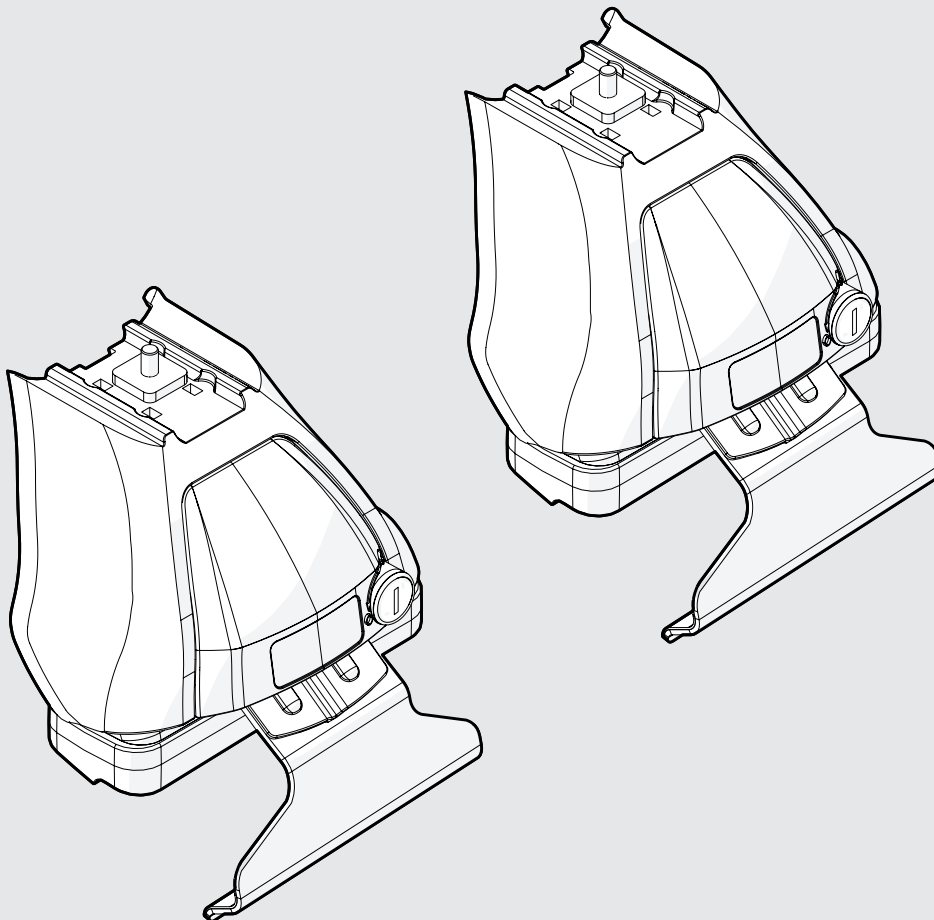



Carrying Capacity

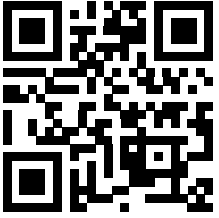



Check the website and the **vehicle owners hand book** for your vehicle manufacturer's maximum carrying capacity. Load must be evenly distributed over the system.

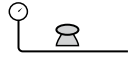
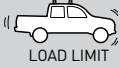

VISIT THE ONLINE CALCULATOR FOR CURRENT SYSTEM LOAD LIMIT DATA

DYNAMIC LOAD LIMIT:
*USE THE VEHICLE MANUFACTURER'S MAXIMUM ROOF ALLOWANCE IF IT IS LOWER THAN THE FIGURE LISTED

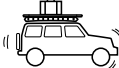
 CARGO UP TO 40 KG 88 lbs	+	 SYSTEM WEIGHT 3 KG 6.8 lbs	=	 LOAD LIMIT UP TO 43 KG 94.8 lbs	OR	 Max kg *VEHICLE MANUFACTURER'S ROOF LOAD LIMIT
---	---	---	---	--	----	---

 Cargo Load Limit <hr/> Total permissible weight allowed on top, and attached to roof racks whilst the vehicle is in motion.	 System Weight <hr/> Total weight of the roof rack system. (e.g. Crossbars, Backbone, Platform)	 Max System Load Capacity <hr/> Please ensure you use the vehicle manufacturer's maximum roof allowance if it is lower than the figure listed in the fitting chart/supplement.	 Vehicle Manufacturer's Load Limit <hr/> Total permissible weight attached to the roof of the car. This is inclusive of the weight of the roof rack system.
--	---	--	---

In service maintenance checks

- All bolt connections should be checked after driving a short distance when you first install your roof racks.
- All bolted connections should be checked again at regular intervals (weekly is recommended, depending on road conditions, usage, loads and distances travelled).
- All bolted connections should be checked each time they are re-fitted.
- Off-road conditions are more rigorous. Check all bolted connections and your load more regularly.
- Ensure that your vehicle manufacturer's GVM, and gross axle weights are not exceeded (refer to vehicle owner's manual).

Torque Settings:

Unless stated otherwise in these instructions, all fasteners should be set to the following torque settings:

 4-5Nm 3-4lbs/ft	 8-10Nm 6-7.5lbs/ft	 16-18Nm 12-13lbs/ft
---	--	---

Note for Dealers and Fitters

It is your responsibility to ensure these fitting instructions are given to the end user or client. These instructions remain the property of Rhino-Rack Australia Pty. Ltd. and may not be used or changed for any other purpose than intended.





Youtube.com/
Rhinorackaustralia

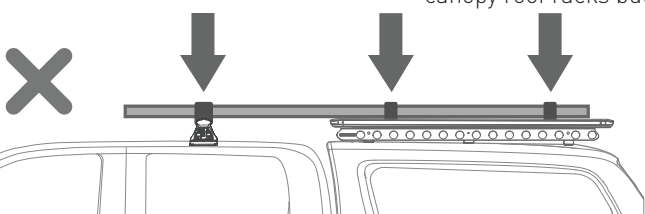

Tub/tray/canopys can move independently from the vehicle cabin. Rigidly fix to either the cabin roof racks **or** the tub/tray/canopy roof racks but not both simultaneously.

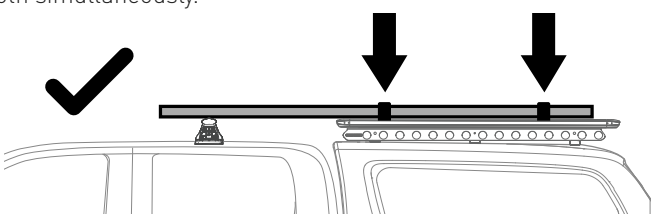

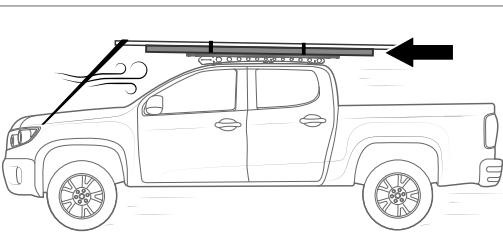

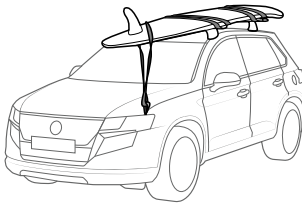

Long flexible loads must be securely attached to a **rigid support** and be tied down to the bonnet.





Paddle/ Surfboards should be fixed to the front of the vehicle.

Use only **non-stretch** fastening ropes or straps to attach cargo to roof racks. Always ensure you fasten your load to the crossbar securely,

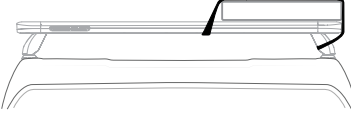
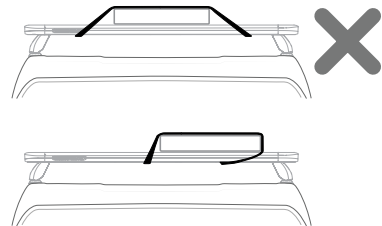

Loads must be tied down to roof rack, **NOT** around legs



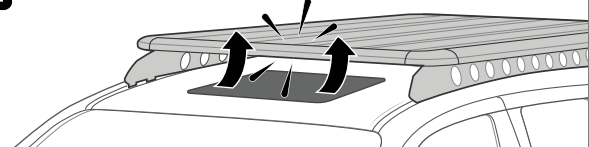
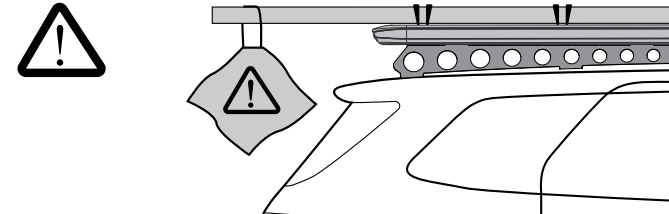
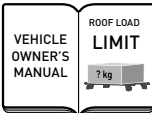

Ensure sunroof will not collide with roof rack system.

VEHICLE OWNER'S MANUAL

ROOF LOAD LIMIT
? kg

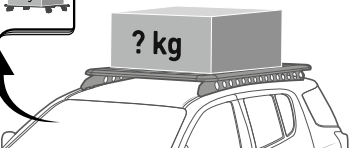
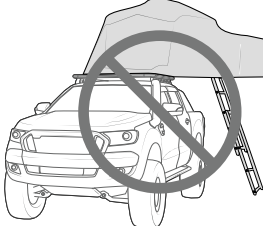
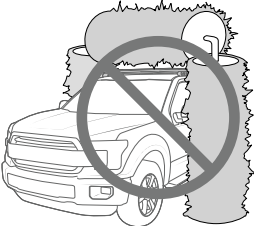

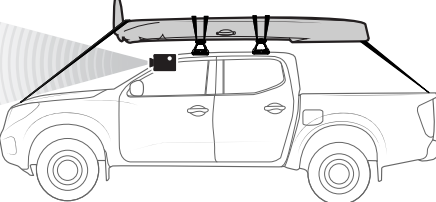

Racks must be removed when vehicle is put through an automatic car wash.

Warranty for roof rack system will be void if the front of the kayak is not secured to the bonnet

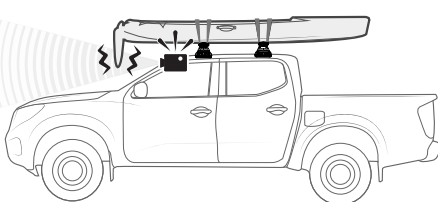

Do NOT obstruct windscreen camera sensors

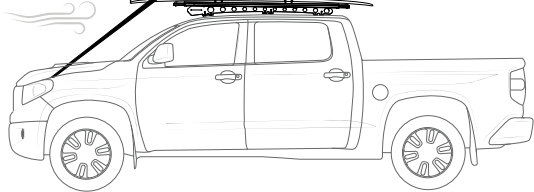
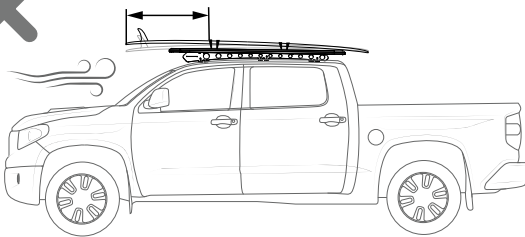

Surfboard Overhang >600mm must be tied to the bonnet

Exercise extreme care when transporting wind-resistant loads. Special consideration must be taken when cornering and braking.

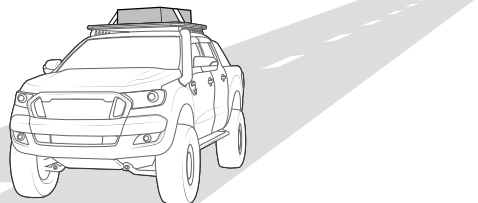

Off-road conditions can be much more rigorous. Extreme care must be taken on any driven path that does not contain a surface protection layer (tar/bitumen).



System Components

To complete the installation ensure you have **Base Kit, Legs** and **Crossbars**.

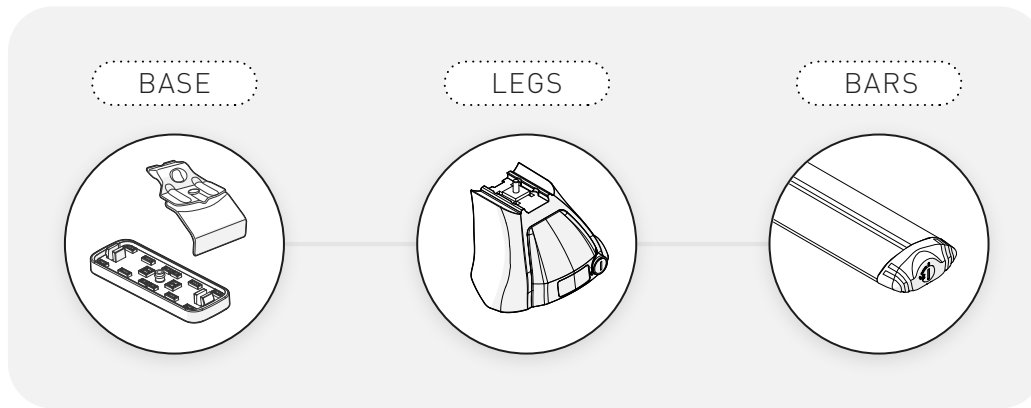

TOOLS REQUIRED:

- T1** - Scissors / Cutters
- T2** - Measuring Tape

Parts List

<p>Leg</p> <p>A x2</p>	<p>Front Cover Preassembled</p> <p>B x2</p>	<p>Metal Key (Pair)</p> <p>C x1</p>	<p>Foot Plate</p> <p>D x2</p>
<p>Torque Key</p> <p>E x1</p>	<p>Location Decals Sheet</p> <p>F x1</p>	<p>Positioning Decals Sheet</p> <p>G x1</p>	<p>Instruction</p> <p>H x1</p>
<p>DK PARTS (Included in Base Kit)</p> <p>I x2 J x2</p>		<p>CROSS BAR (Included in Bars Kit)</p> <p>K x1</p>	

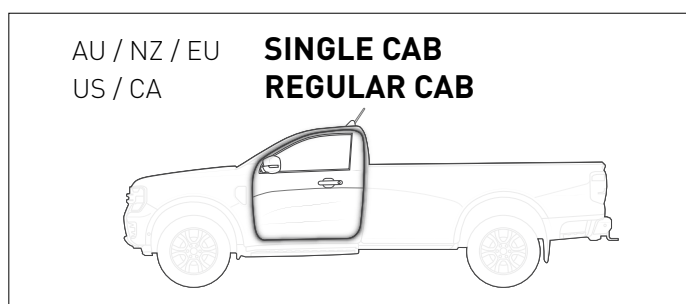

1

LEGS

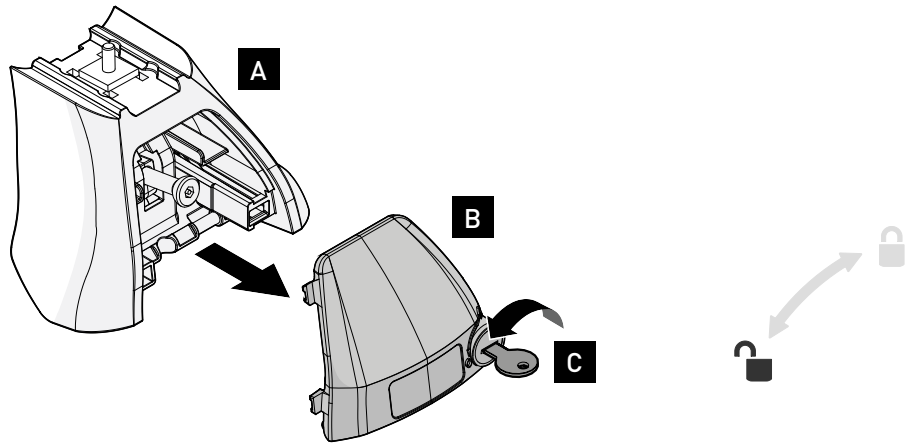

2

LEGS



LEGS

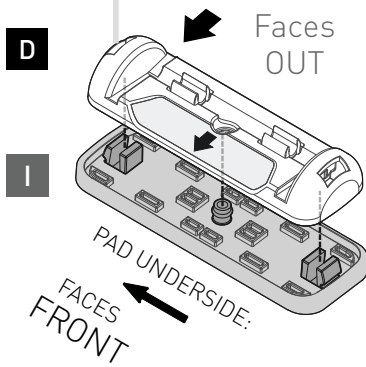
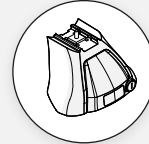

PAD ID:

100-006-00051

BASE KIT

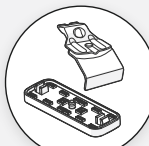

FRONT

FL

FR

OUT

OUT

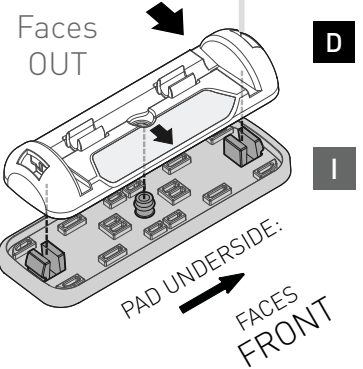
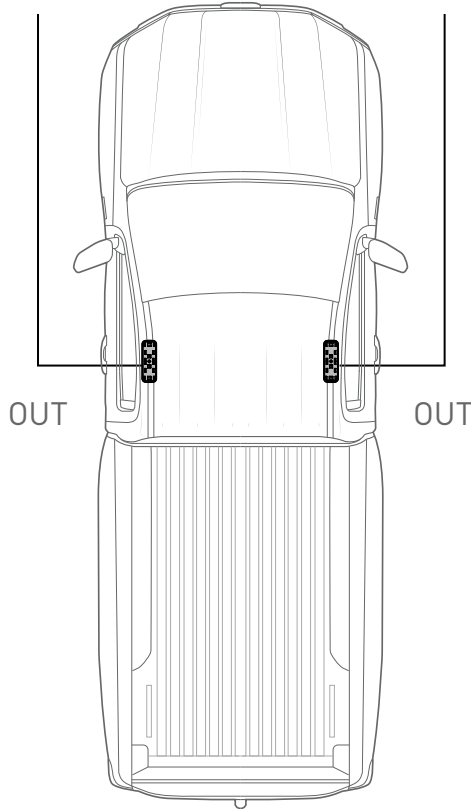

PAD ID:

100-006-00052

BASE KIT

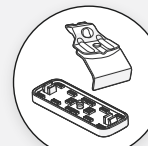

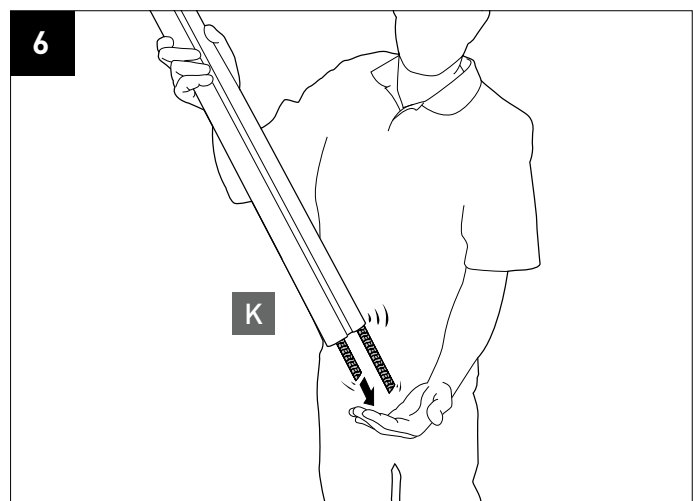
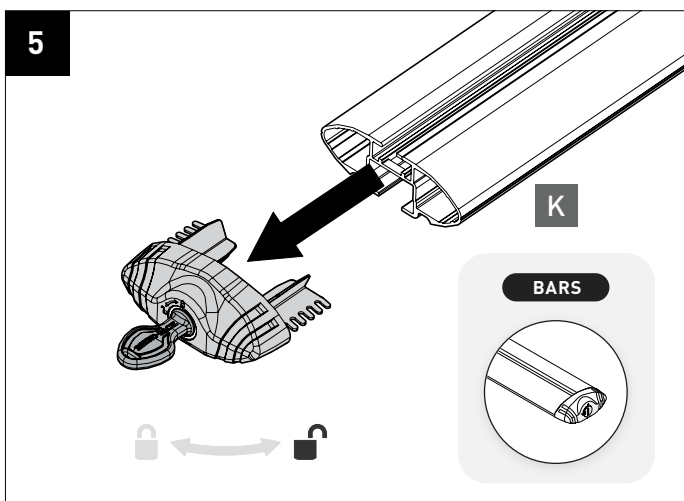
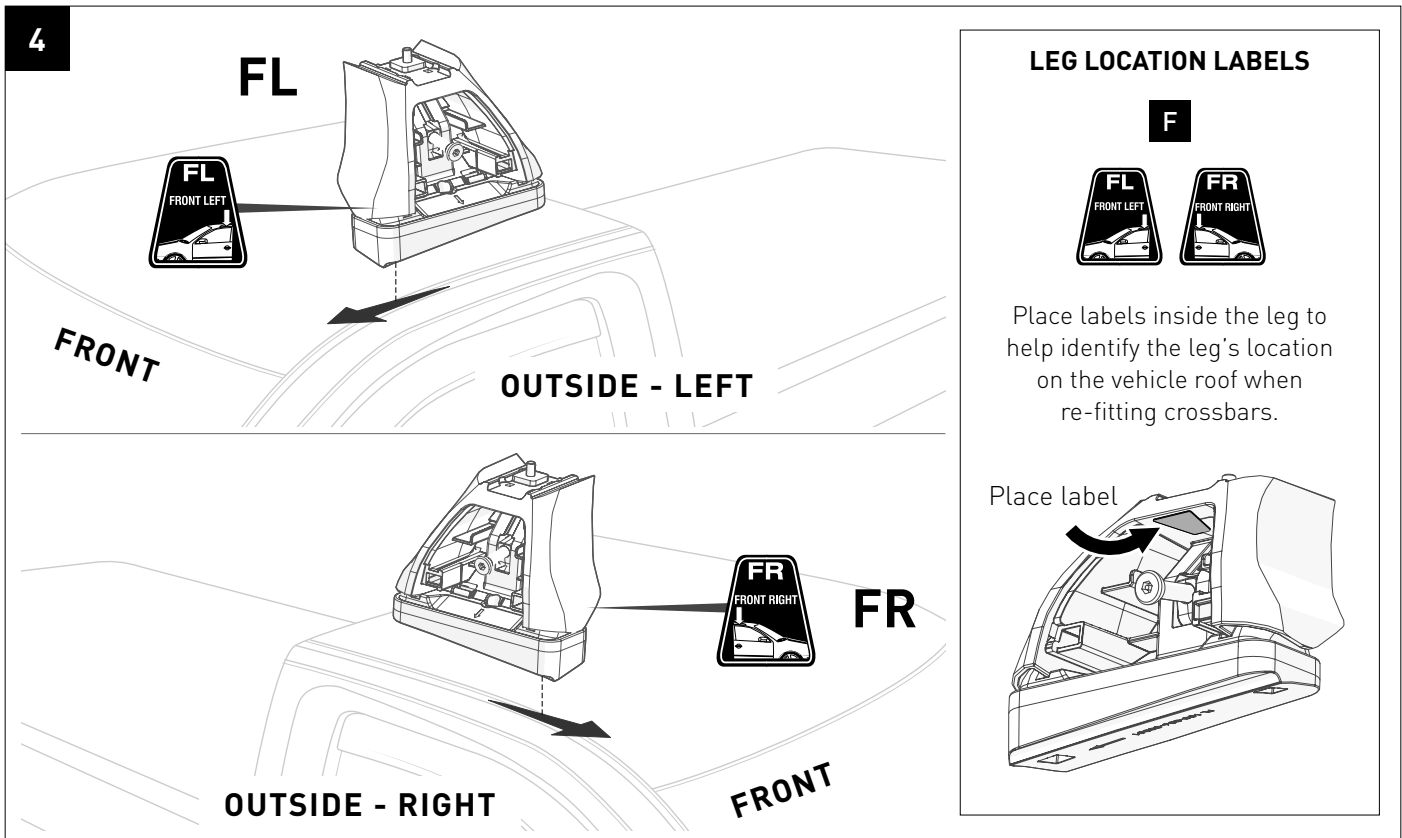
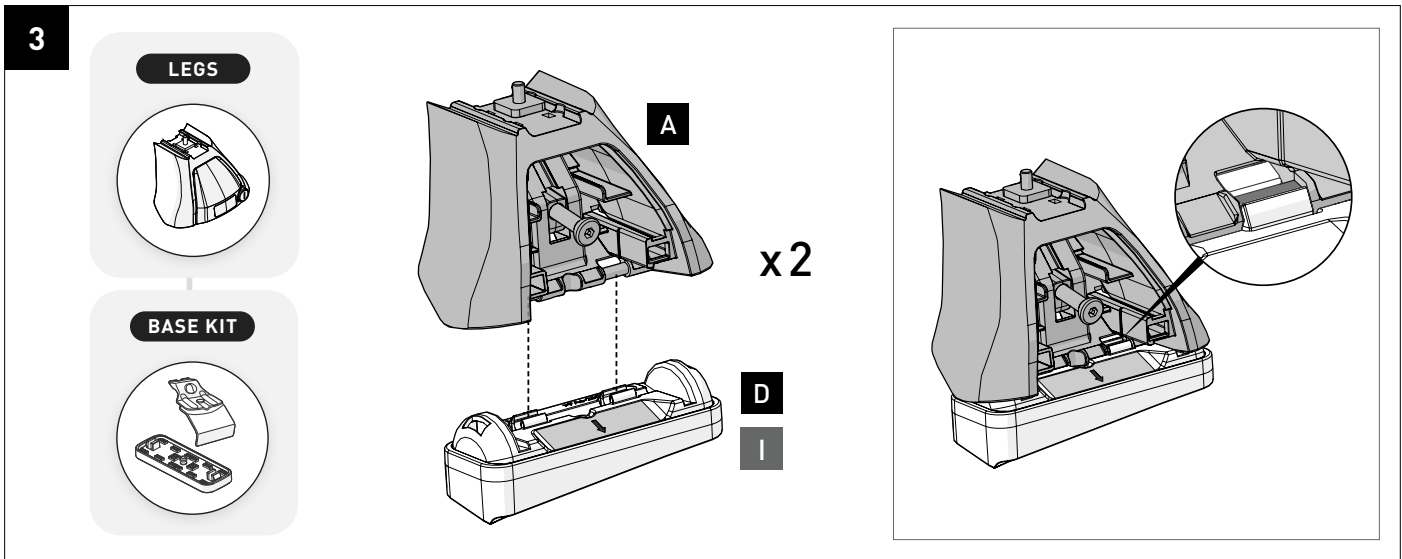

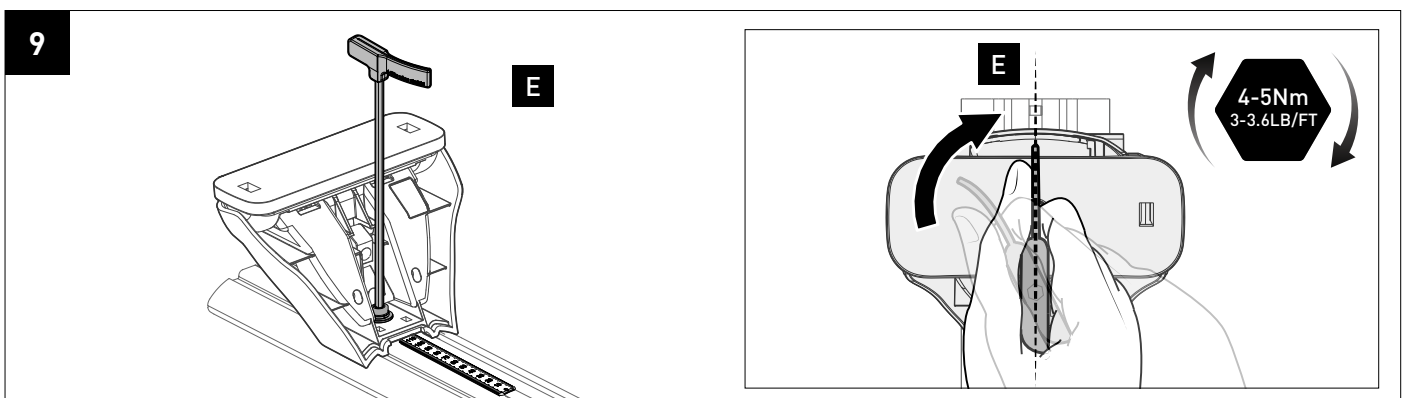
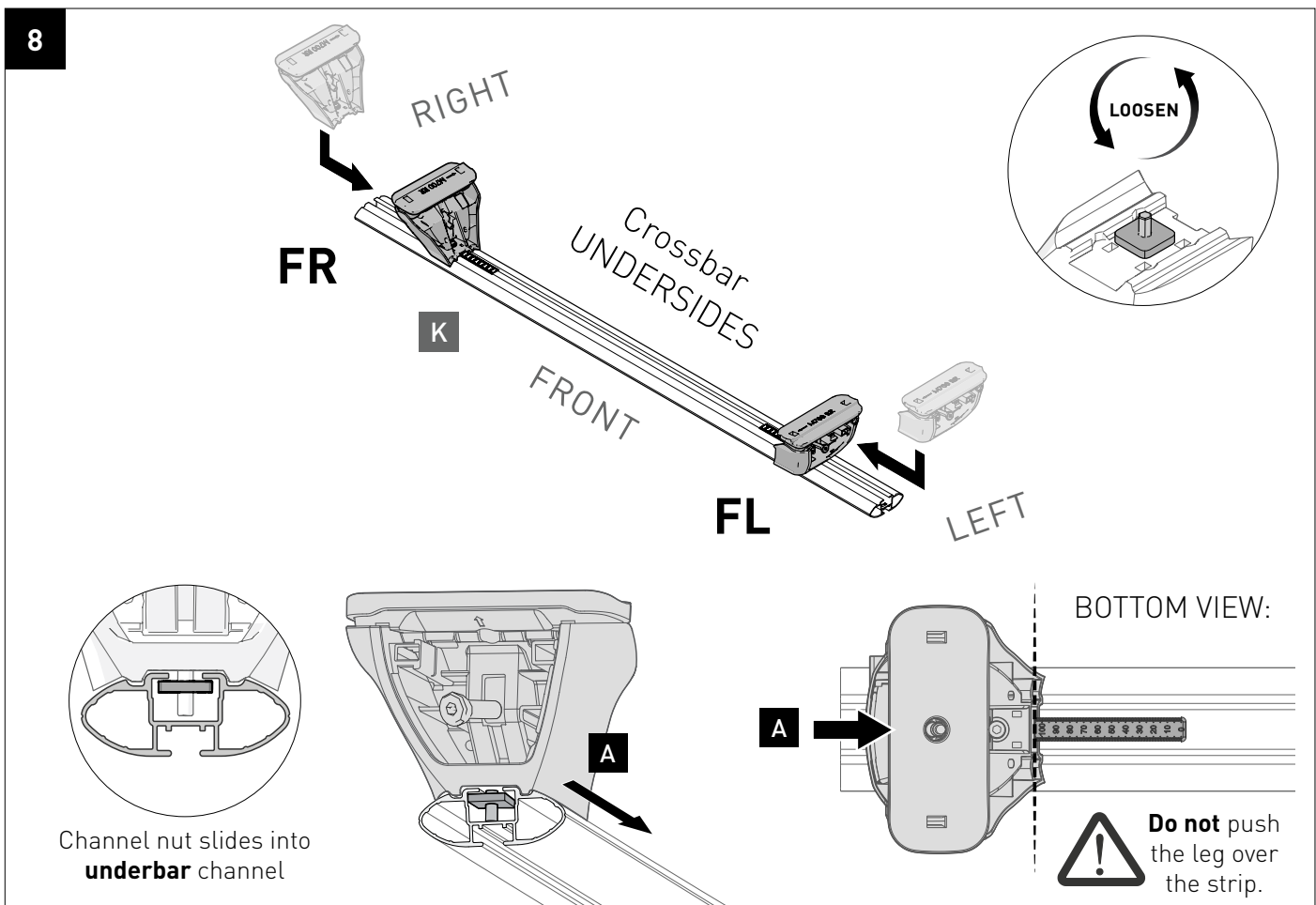
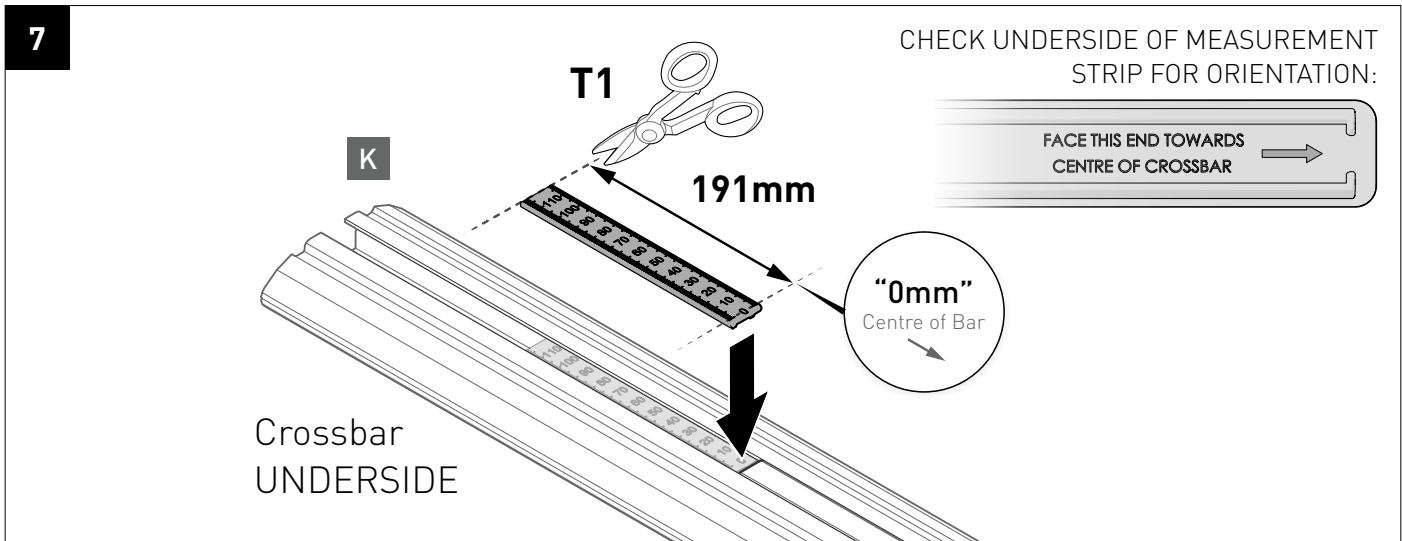

10

Repeat for all crossbar ends.

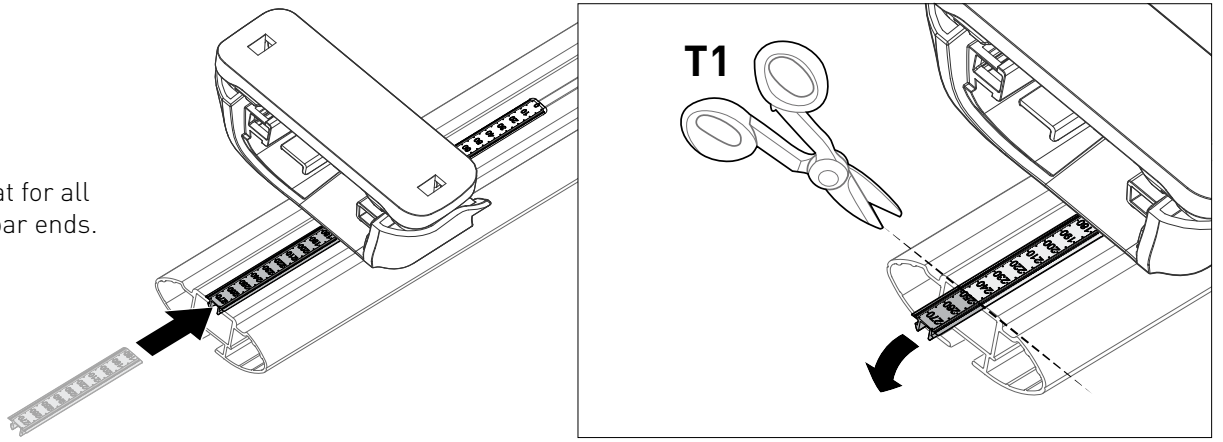

11

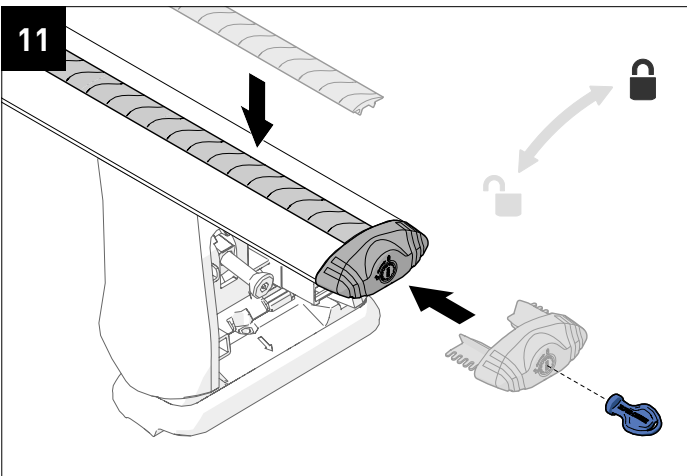

12

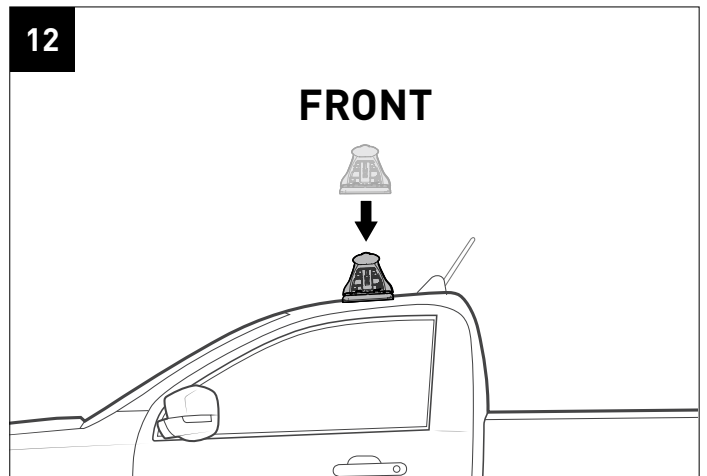

13

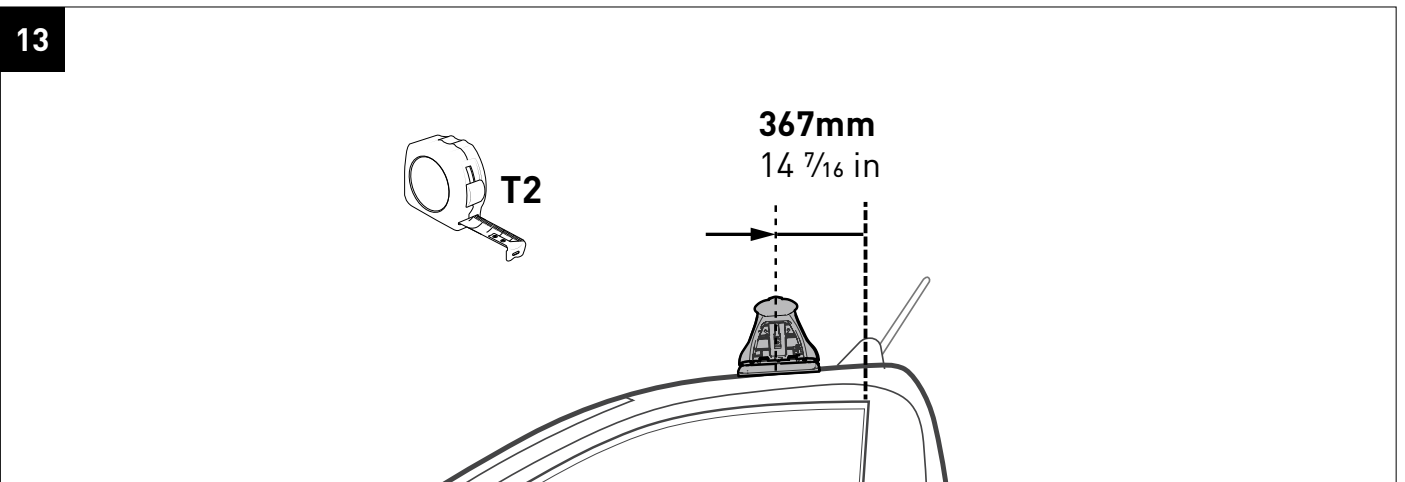

14

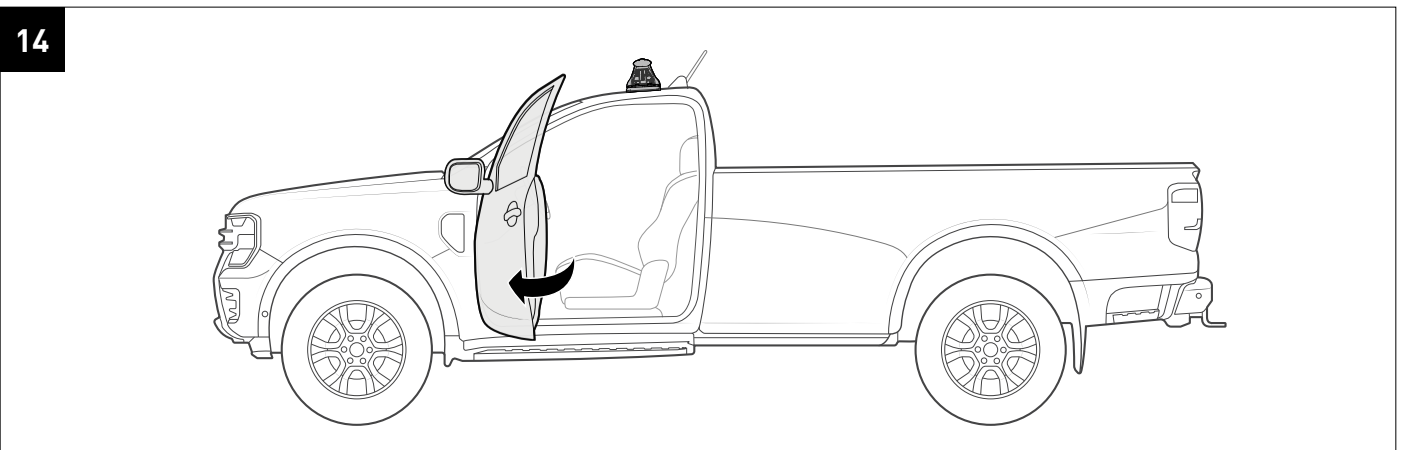

15

LEG POSITION DECALS

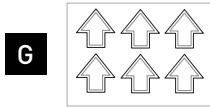

Adhere the arrow decals in line with foot plate arrows for future reference.

Note: When the door is shut, the sticker should not be visible. Place in door jamb accordingly.

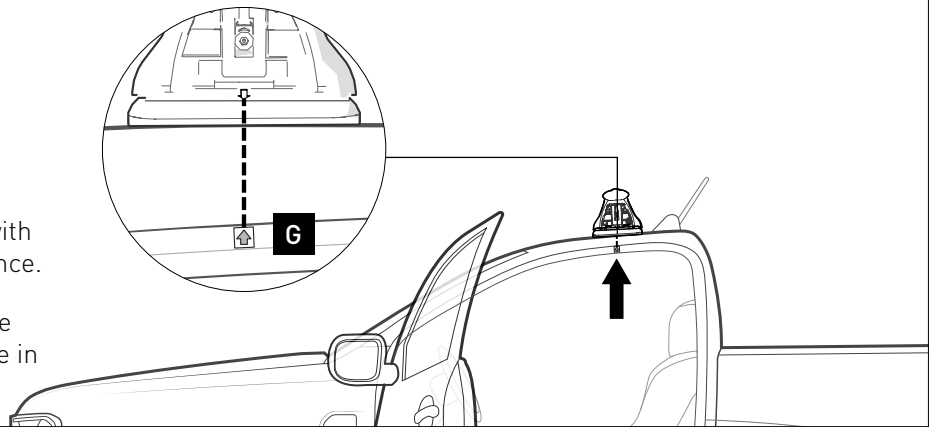

16

CLAMP ID:

100-001-00118

FRONT

CLAMP ID:

100-001-00118

J

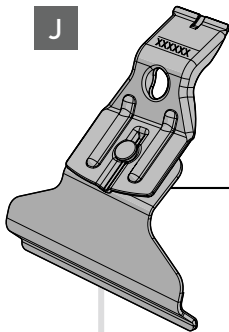

BASE KIT

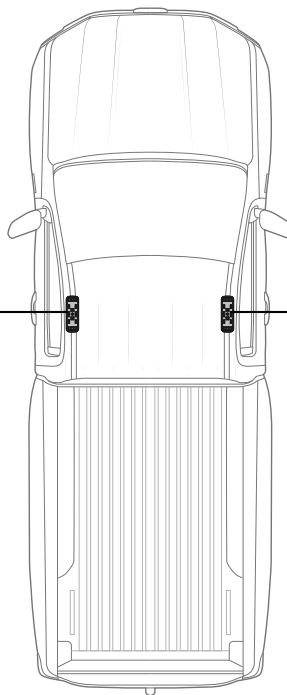
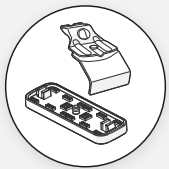

J

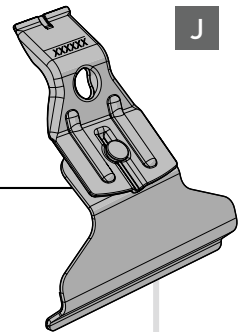

BASE KIT

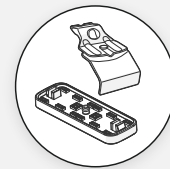

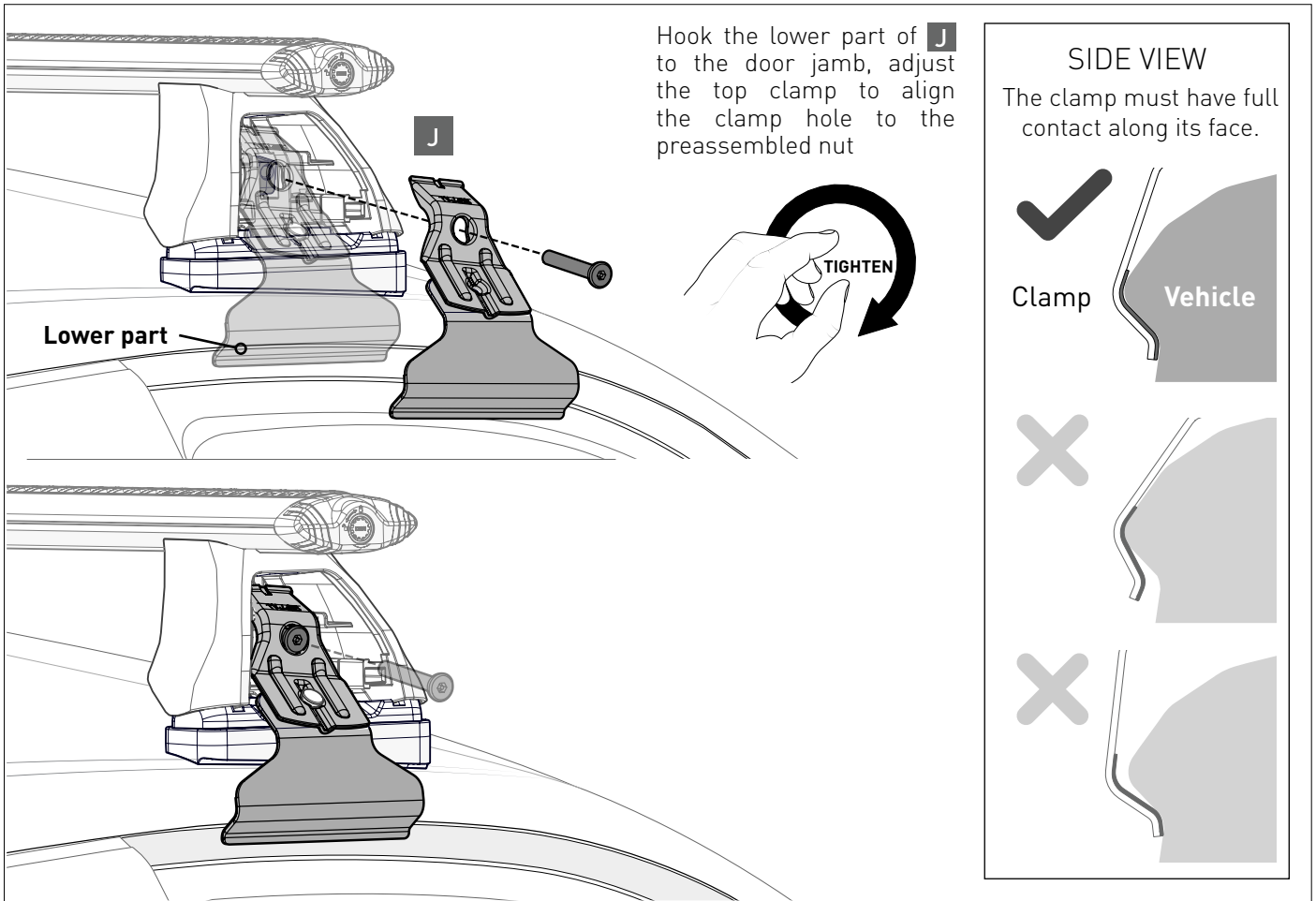

18 Visually inspect and ensure that the pads are correctly seated against the body of the vehicle.

FRONT VIEW

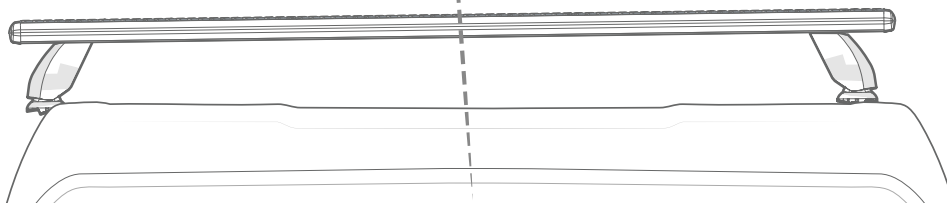
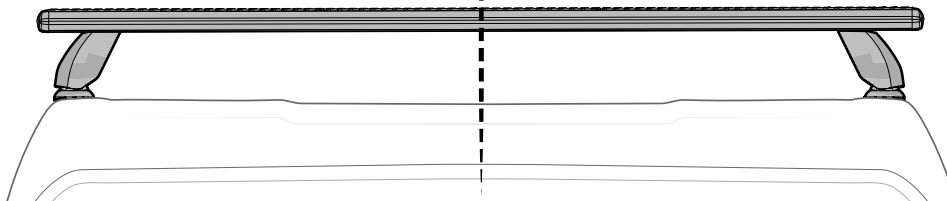

19

Tighten bolts incrementally and evenly on each side of the vehicle to avoid pulling the rack to one side.



Do not over tighten.



SIDE VIEW

The clamp must have full contact along its face.

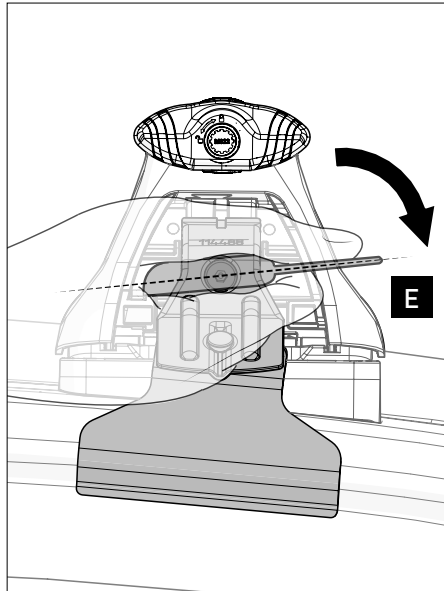
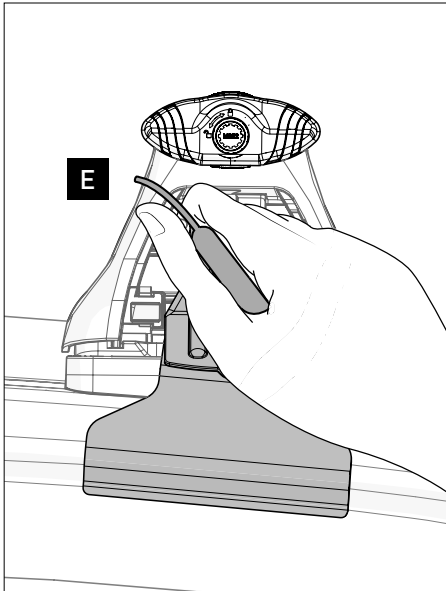
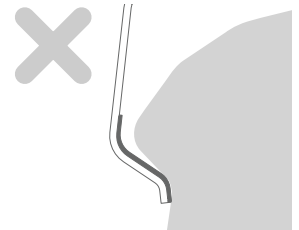
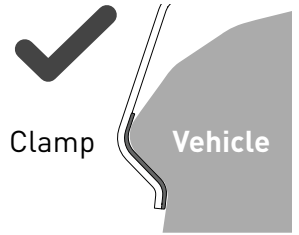

20

Check fitment is secure

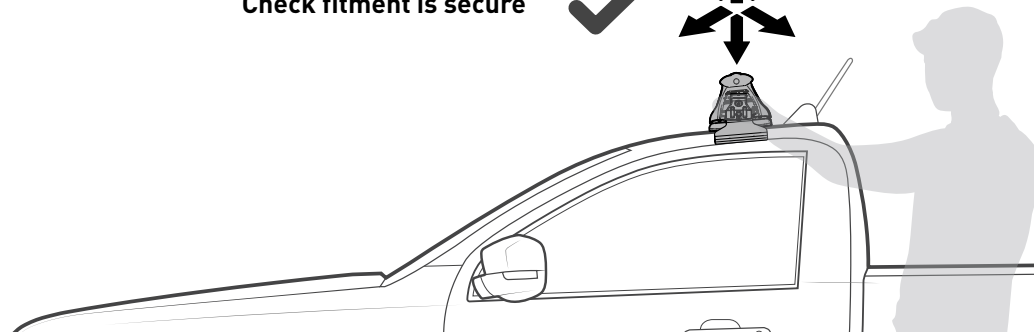
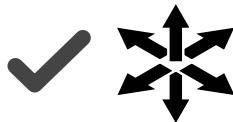

21

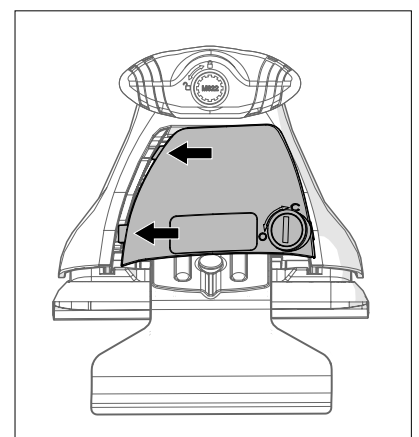
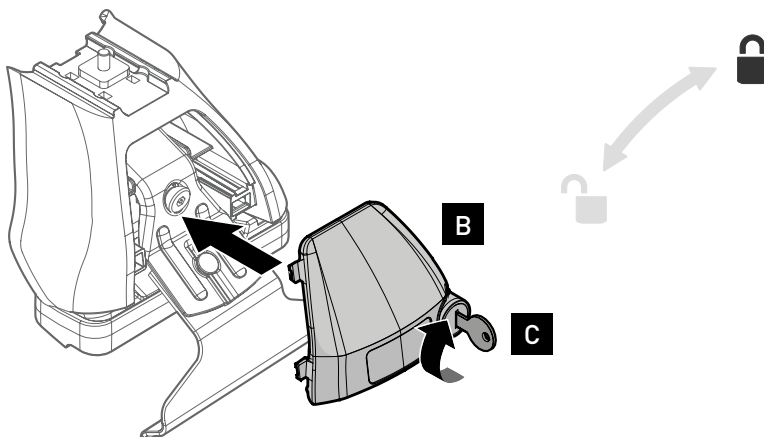

NOTE

Cut and install vortex strips around the accessories if required.

