

# RHINO-RACK

## BASE KIT - RCP98-BK

**Important:**

1. Check the Rhino-Rack website to ensure you have the latest issue of these instructions.
2. Please refer to your fitting instruction to ensure that the roof racks are installed in the correct locations.
3. Check the contents of kit before commencing fitment and report any discrepancies.
4. Place these instructions in the vehicle's glove box after installation is complete.
5. These instructions must be followed for warranty to be upheld.

**Fit Time:** 30 minutes

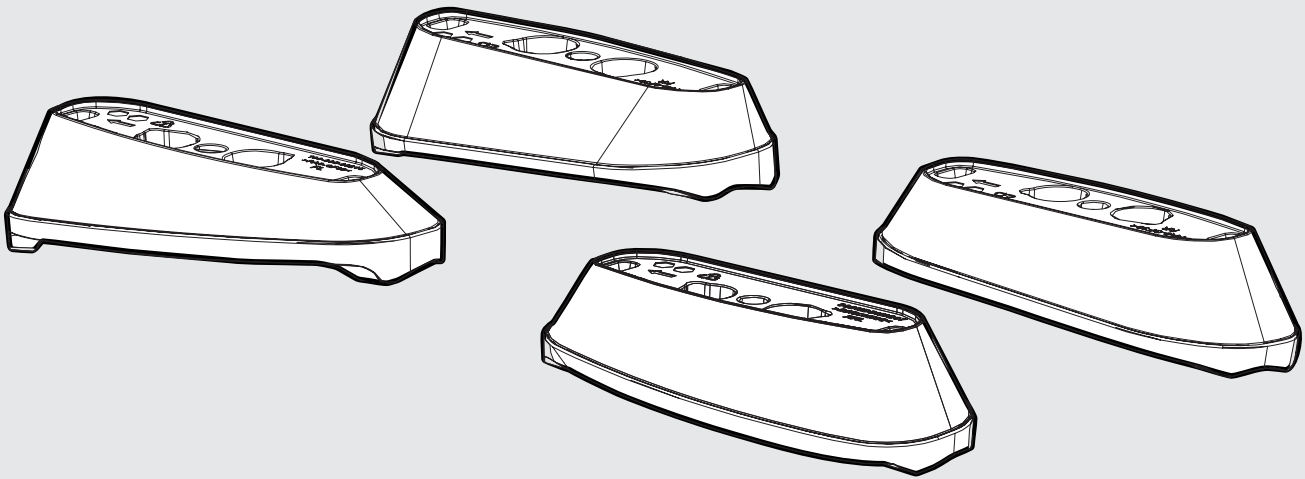

# RCP98-BK Instructions

## Carrying Capacity

Check the website and the vehicle owners hand book for your vehicle manufacturer's maximum carrying capacity. Load must be evenly distributed over the system.



### Cargo Load Limit

Total permissible weight allowed on top, and attached to roof racks whilst the vehicle is in motion.



### System Weight

Total weight of the roof rack system. (e.g. Crossbars, Backbone, Platform)



### Max System Load Capacity

Please ensure you use the vehicle manufacturer's maximum roof allowance if it is lower than the figure listed in the fitting chart/supplement.



### Vehicle Manufacturer's Load Limit

Total permissible weight attached to the roof of the car. This is inclusive of the weight of the roof rack system.

## Warning

- Check part number or kit is correct for use with your vehicle.
- Do not attempt to fit the rack system to your vehicle unless you fully understand these fitting instructions. Please direct any questions regarding fitting to the dealer from where the roof racks were purchased.
- Off-road conditions can be much more rigorous. Extreme care must be taken on any driven path that does not contain a surface protection layer (tar/bitumen).
- Roof racks must be removed when vehicle is put through an automatic car wash.
- With utility vehicles, the cabin and the canopy move independently. Roof racks and vehicle can be damaged if the item transported is rigidly fixed at points on both the cabin and canopy. Instead, rigidly fix to either the cabin roof racks or the canopy roof racks.
- Always ensure you fasten your load securely.
- Use only non-stretch fastening ropes or straps to attach cargo to your load.

## In service maintenance checks

- All bolt connections should be checked after driving a short distance when you first install your roof racks.
- All bolted connections should be checked again at regular intervals (weekly is recommended, depending on road conditions, usage, loads and distances travelled).
- All bolted connections should be checked each time they are re-fitted.
- Off-road conditions are more rigorous. Check all bolted connections and your load more regularly.
- Ensure that your vehicle manufacturer's GVM, and gross axle weights are not exceeded (refer to vehicle owner's manual).

### Torque Settings:



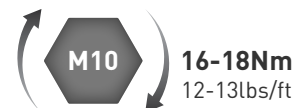

Unless stated otherwise in these instructions, all fasteners should be set to the following torque settings:

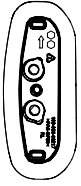
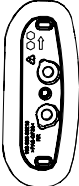
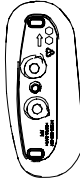
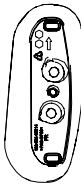

## Note for Dealers and Fitters

It is your responsibility to ensure these fitting instructions are given to the end user or client. These instructions remain the property of Rhino-Rack Australia Pty. Ltd. and may not be used or changed for any other purpose than intended.

## Parts List

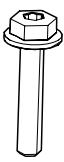
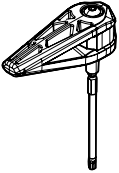
<p>Front Left Pad (FL)</p>  <p><b>A</b> x1</p>	<p>Front Right Pad (FR)</p>  <p><b>B</b> x1</p>	<p>Rear Left Pad (RL)</p>  <p><b>C</b> x1</p>	<p>Rear Right Pad (RR)</p>  <p><b>D</b> x1</p>
<p>Front Left Gasket (FL)</p>  <p><b>E</b> x1</p>	<p>Front Right Gasket (FR)</p>  <p><b>F</b> x1</p>	<p>Rear Left Gasket (RL)</p>  <p><b>G</b> x1</p>	<p>Rear Right Gasket (RR)</p>  <p><b>H</b> x1</p>
<p>M6 x 30 mm Hex Head (T30)</p>  <p><b>I</b> x12</p>	<p>Torque Tool (3NM)</p>  <p><b>J</b> x1</p>	<p><b>Tools Required</b> T1 - 10mm spanner/torque wrench.</p>	

- 1 Open the **factory caps** to expose the fixed mounting locations.

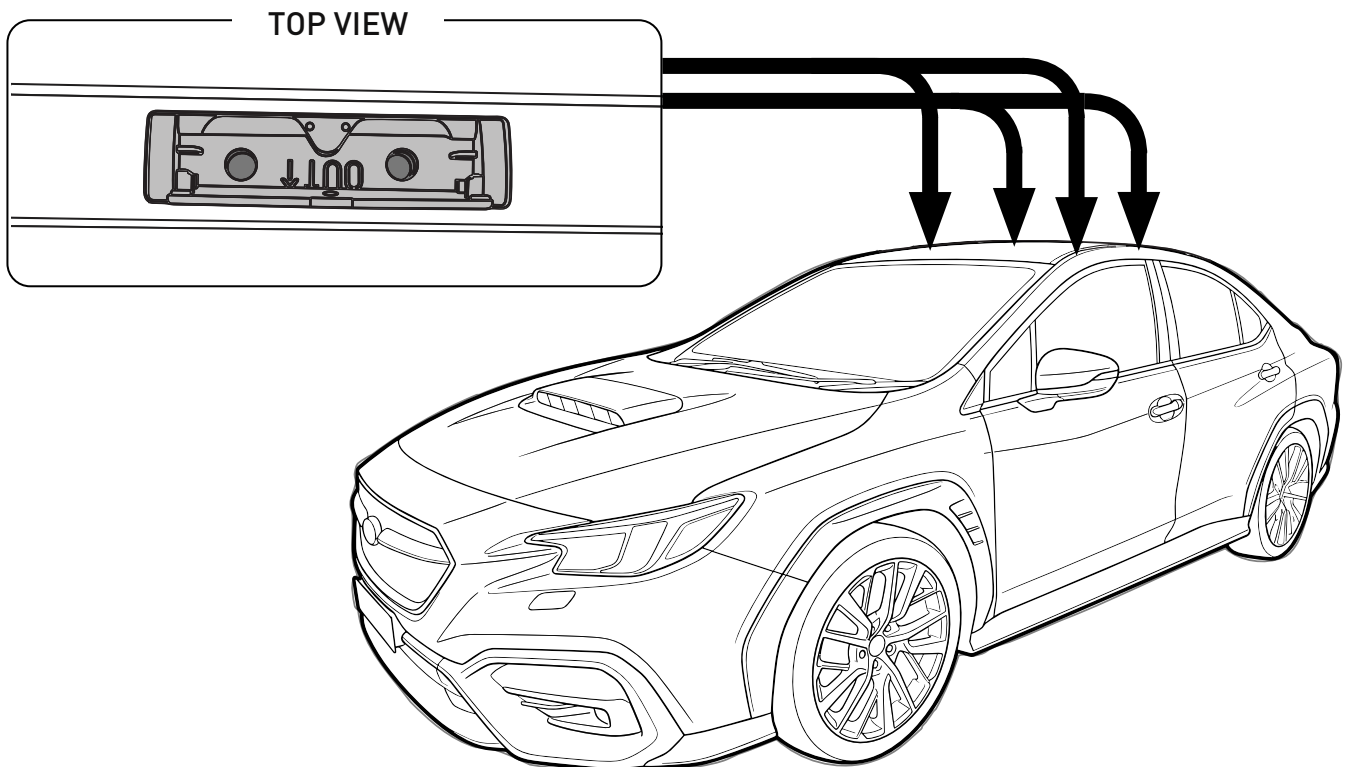

*Note: Vehicle visuals may vary depending on model.*

**2** Identify Pad Positioning Marking (RL) and assemble to corresponding Gasket.

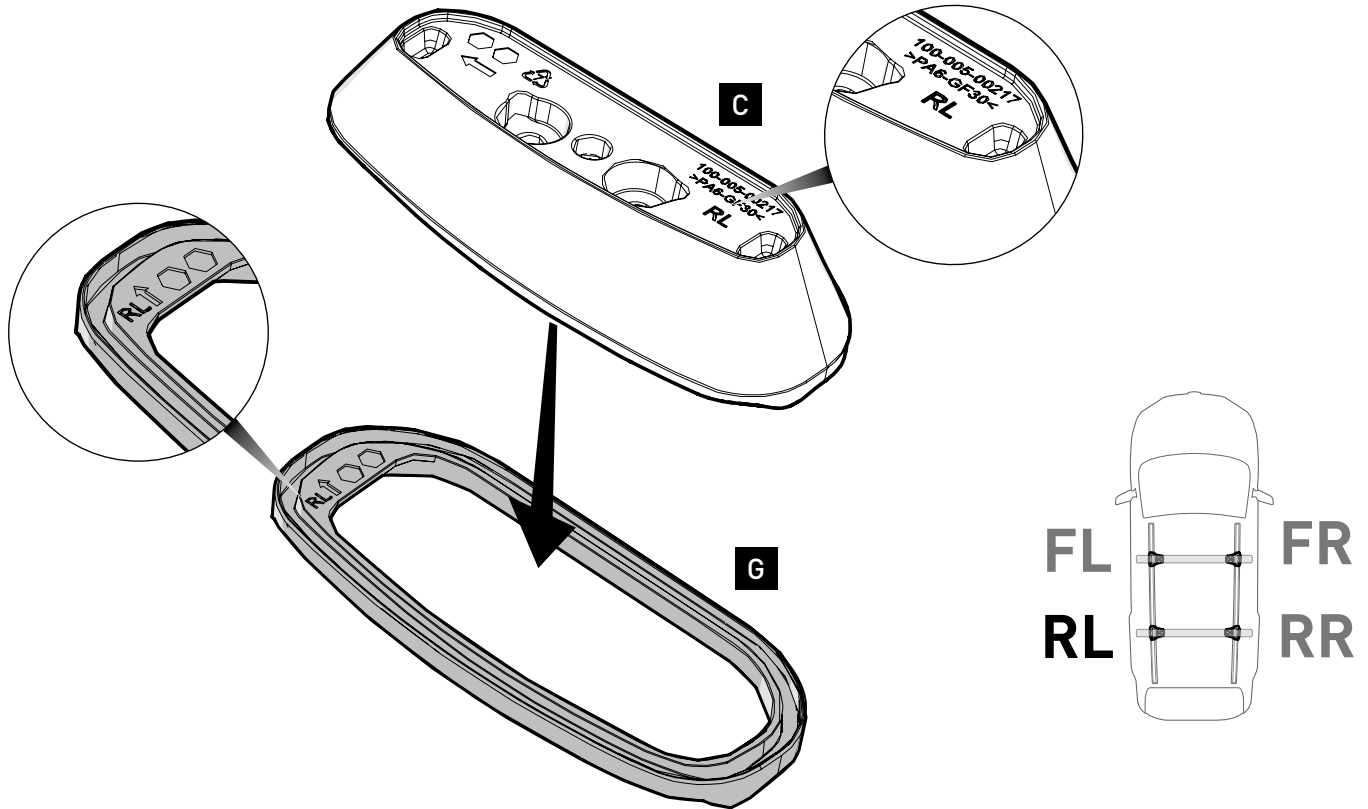

**3** Assemble all remaining Pads to the corresponding Gaskets.

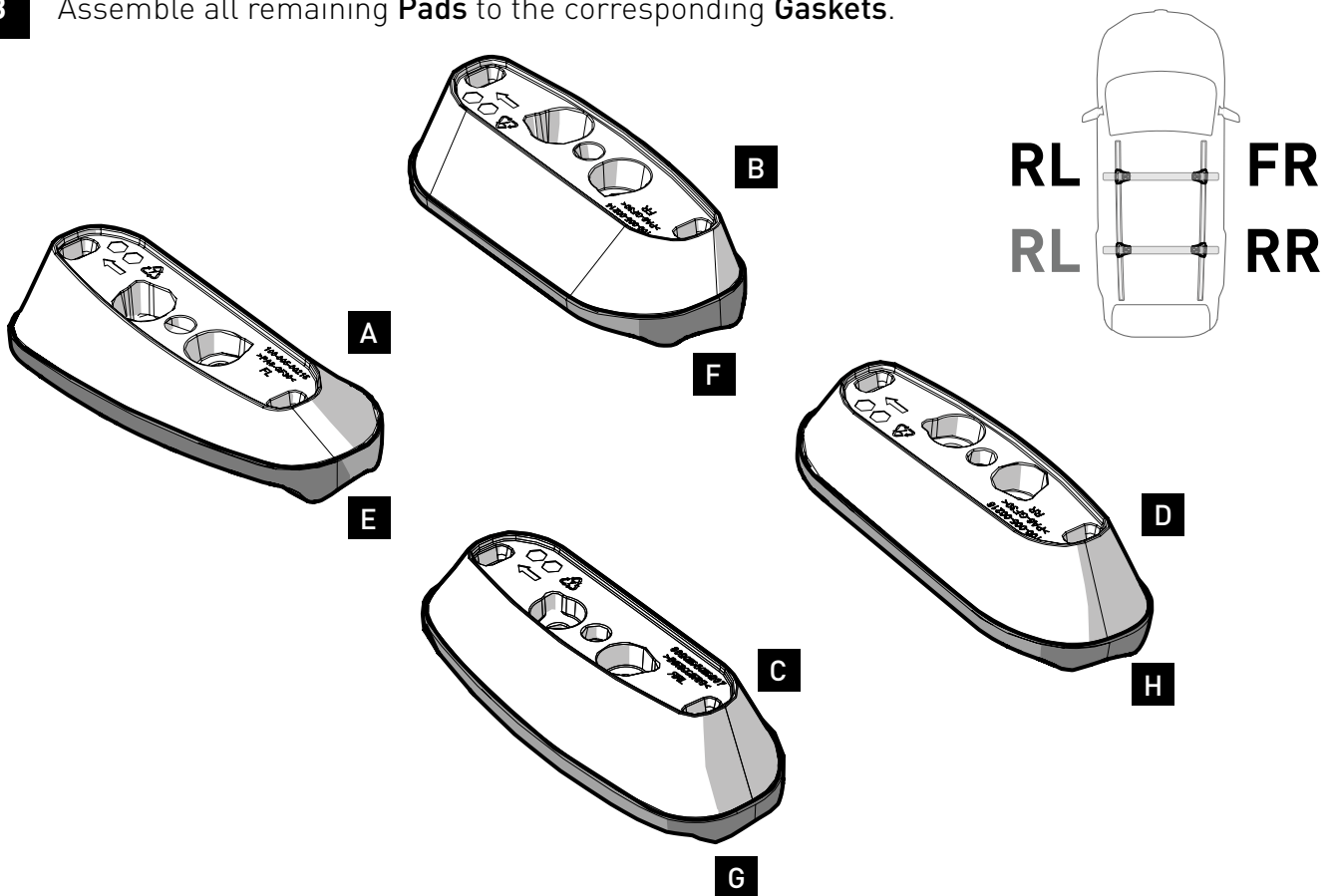

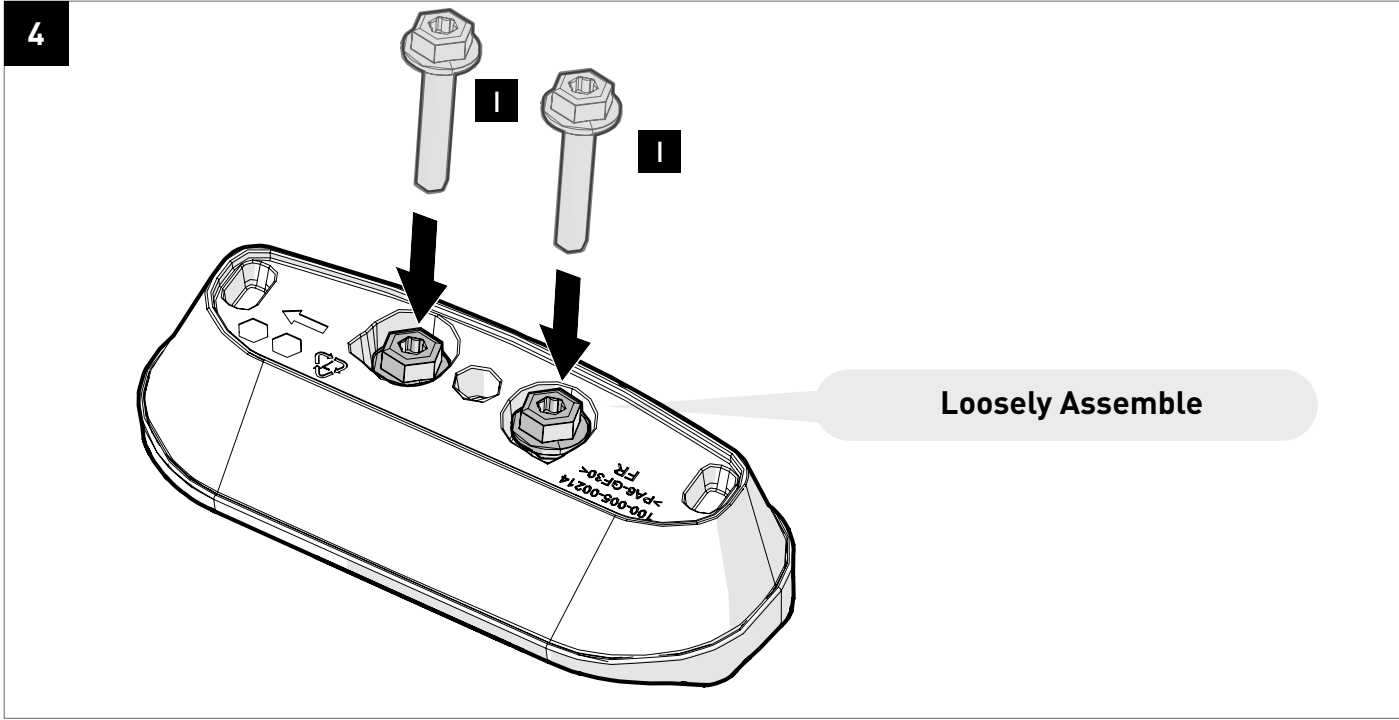

**5** Fit the assembled **Pads** to the corresponding corners.

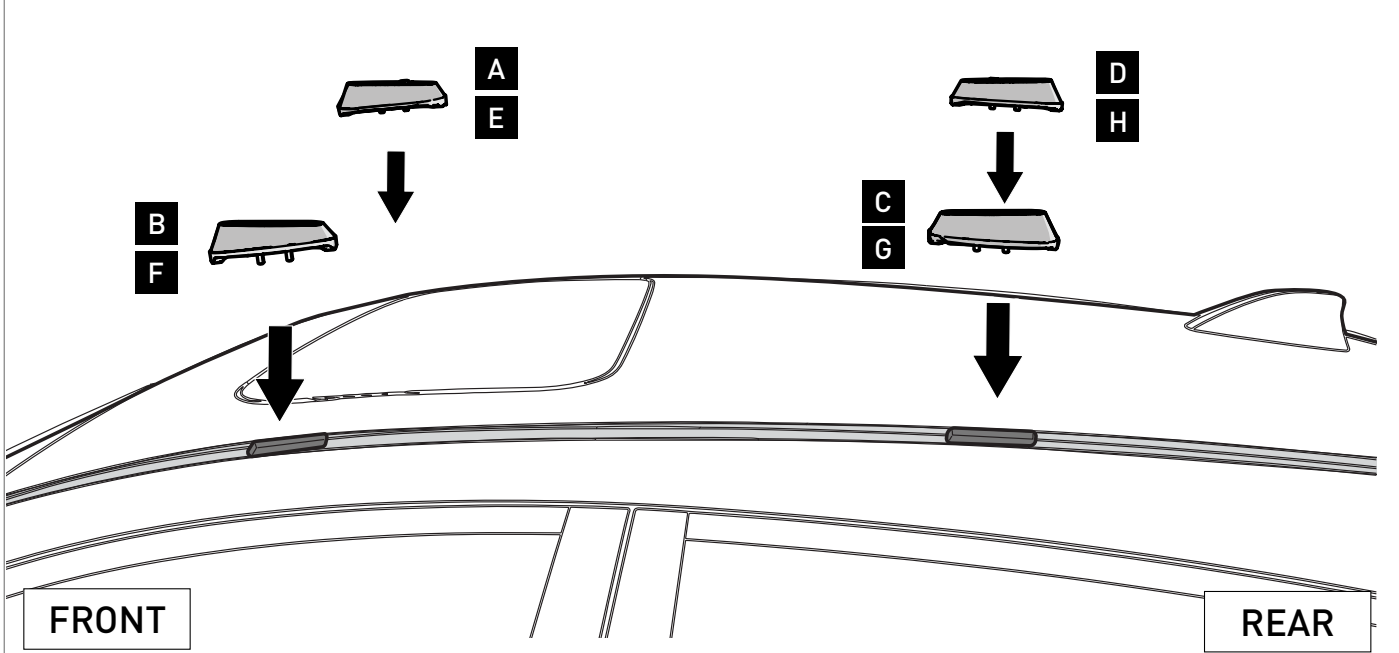

**SIDE VIEW**

Ensure all **Arrows** are facing **Forwards** towards the *front of the vehicle*.

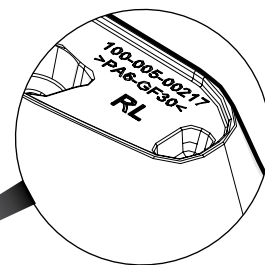
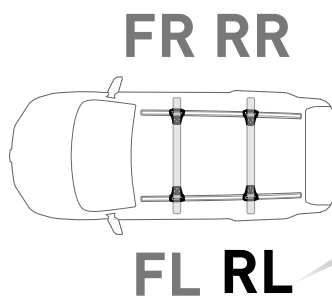
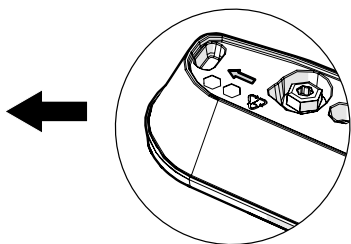

6

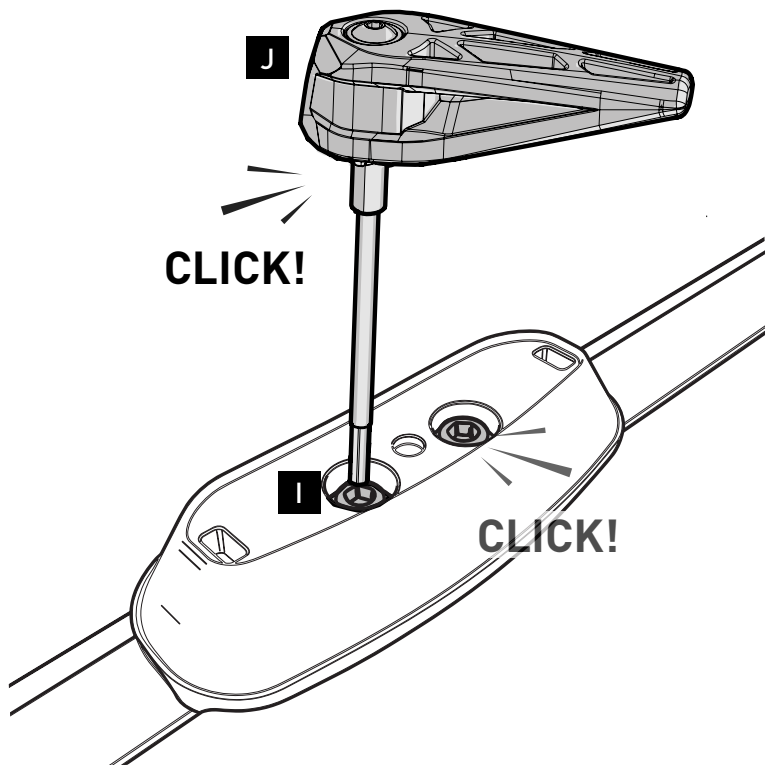

**CLICK!**

3 Nm  
2.2 LB/FT

Ensure the supplied Torque Tool **J** is used to prevent damage.

7

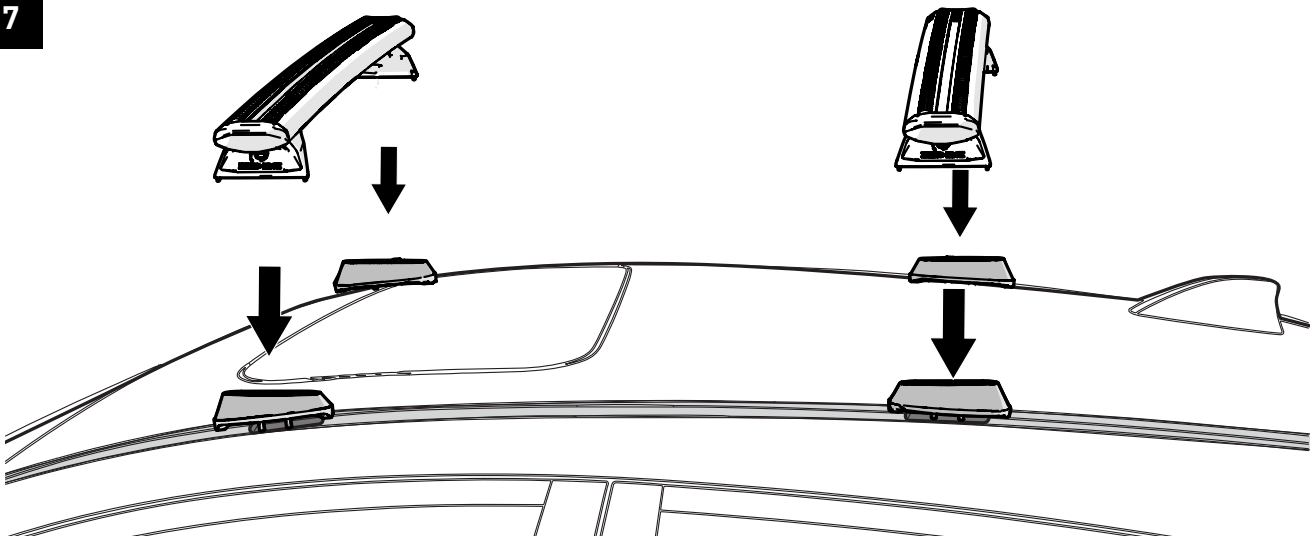

**NOTE**

When installing the leg to the **Base Kit**, use hardware (**I**) supplied in this kit.



*\*Leg visuals may vary depending on fit.*



**T1**

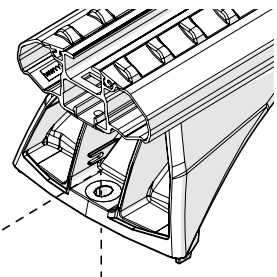

**Proceed to the leg instructions for the remainder of the installation.**