

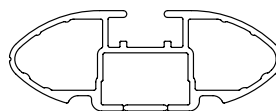

**IDENTIFICATION CHART**

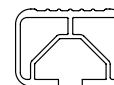







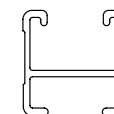

**VA crossbar**

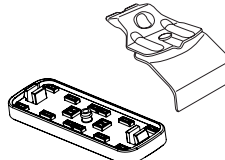

**EURO crossbar**

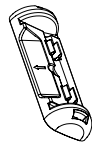
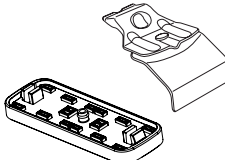

**HD crossbar**

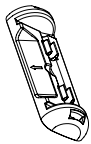
		FRONT CROSSBAR						REAR CROSSBAR						
				 VA	 EURO	 HD	 Foot plate arrow direction			 VA	 EURO	 HD	 Foot plate arrow direction	
Vehicle	Date	Crossbar	Front Right Pad/ Clamp	Front Left Pad/ Clamp	Measurement strip length per side	Measurement strip length per side	Measurement Distance ( x )	Foot plate arrow direction	Rear Right Pad/ Clamp	Rear Left Pad/ Clamp	Measurement strip length per side	Measurement strip length per side	Measurement Distance ( x )	Foot plate arrow direction
Honda Accord 10th Gen	12/19	1260mm	M282 SUB0261	M281 SUB0261	152mm	39mm	952mm / 37, 1/2"	OUT	M281 SUB0261	M282 SUB0261	153mm	40mm	954mm / 37, 9/16"	OUT
			Pad Arrow FOWARD						Pad Arrow FORWARD					



# DK511 Rhino-Rack VA, Euro & HD crossbar instruction

**CONTROLLED**

**Measurement A:** CENTRE of door jamb to CENTRE arrow of leg foot plate.

**Measurement B:** CENTRE of Front leg foot plate arrow to CENTRE of Rear leg foot plate arrow.

**Carrying capacity:** Roof rack is rated to 75kg. Please refer to manufacturers handbook for your vehicles maximum roof load capacity. Always use the lower of the two figures.

If your vehicle is not listed on this fitting instruction please refer to your countries Rhino-Rack web site for the latest information.

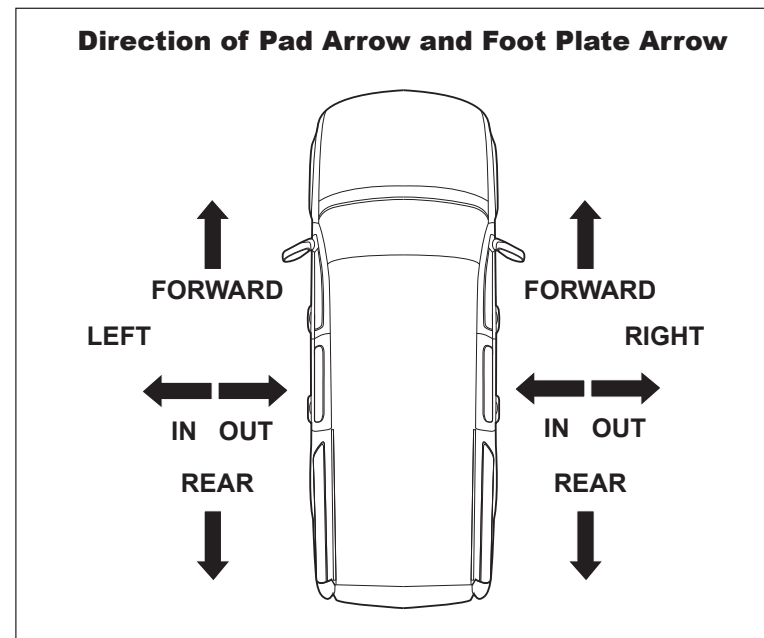
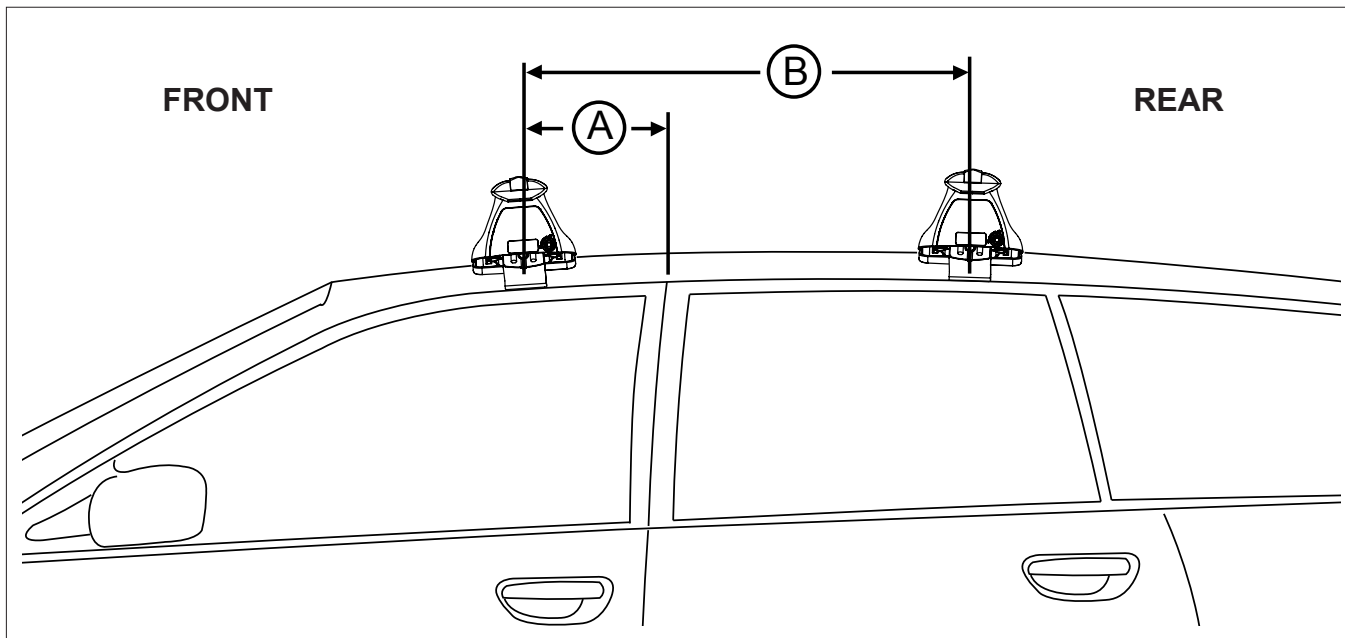

VEHICLE	Date	Measurement A	Measurement B	Load Rating (includes racks 5kg/ 11lbs)
Honda Accord 10th Gen	12/19	225mm / 8 7/8"	700mm / 27, 9/16"	75kg / 165lbs