

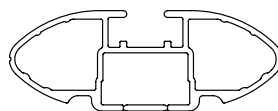

IDENTIFICATION CHART

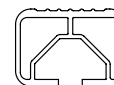







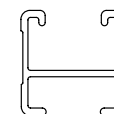

VA crossbar

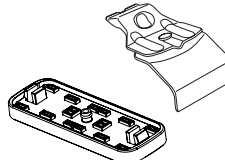

EURO crossbar

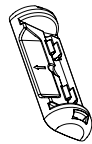
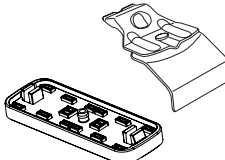

HD crossbar

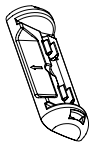
		FRONT CROSSBAR						REAR CROSSBAR						
														
Vehicle	Date	Crossbar	Front Right Pad/ Clamp	Front Left Pad/ Clamp	Measurement strip length per side	Measurement strip length per side	Measurement Distance (x)	Foot plate arrow direction	Rear Right Pad/ Clamp	Rear Left Pad/ Clamp	Measurement strip length per side	Measurement strip length per side	Measurement Distance (x)	Foot plate arrow direction
Honda Pilot 3rd Gen	2016 -	1375mm	M566 SUB0256	M567 SUB0256	203mm	148mm	1169mm / 46,1/32"	OUT	M567 SUB0517	M566 SUB0517	191mm	136mm	1145mm / 45,5/64"	OUT
			Pad Arrow OUT						Pad Arrow OUT					



DK444 DK444F, DK444R Rhino-Rack VA, Euro & HD crossbar instruction

CONTROLLED

Measurement A: CENTRE of door jamb to CENTRE arrow of leg foot plate.

Measurement B: CENTRE of Front leg foot plate arrow to CENTRE of Rear leg foot plate arrow.

Carrying capacity: Roof rack is rated to 75kg. Please refer to manufacturers handbook for your vehicles maximum roof load capacity. Always use the lower of the two figures.

If your vehicle is not listed on this fitting instruction please refer to your countries Rhino-Rack web site for the latest information.

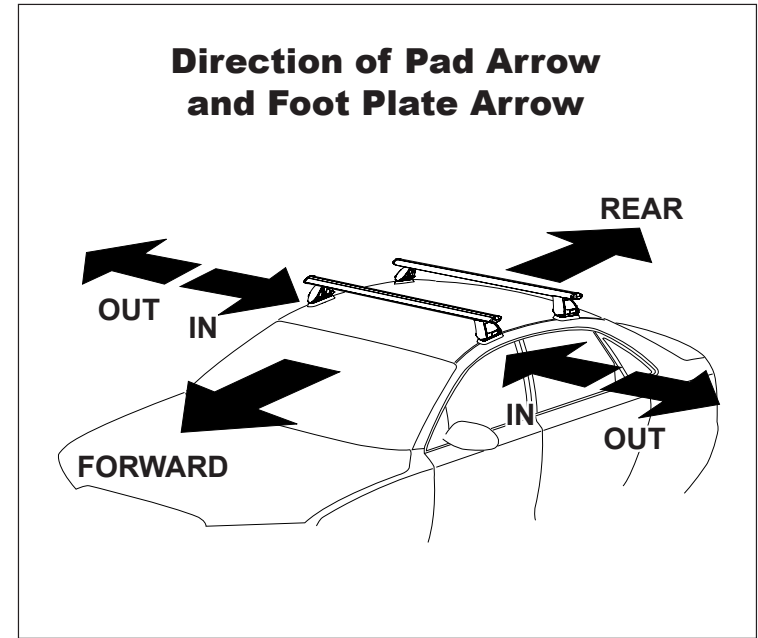
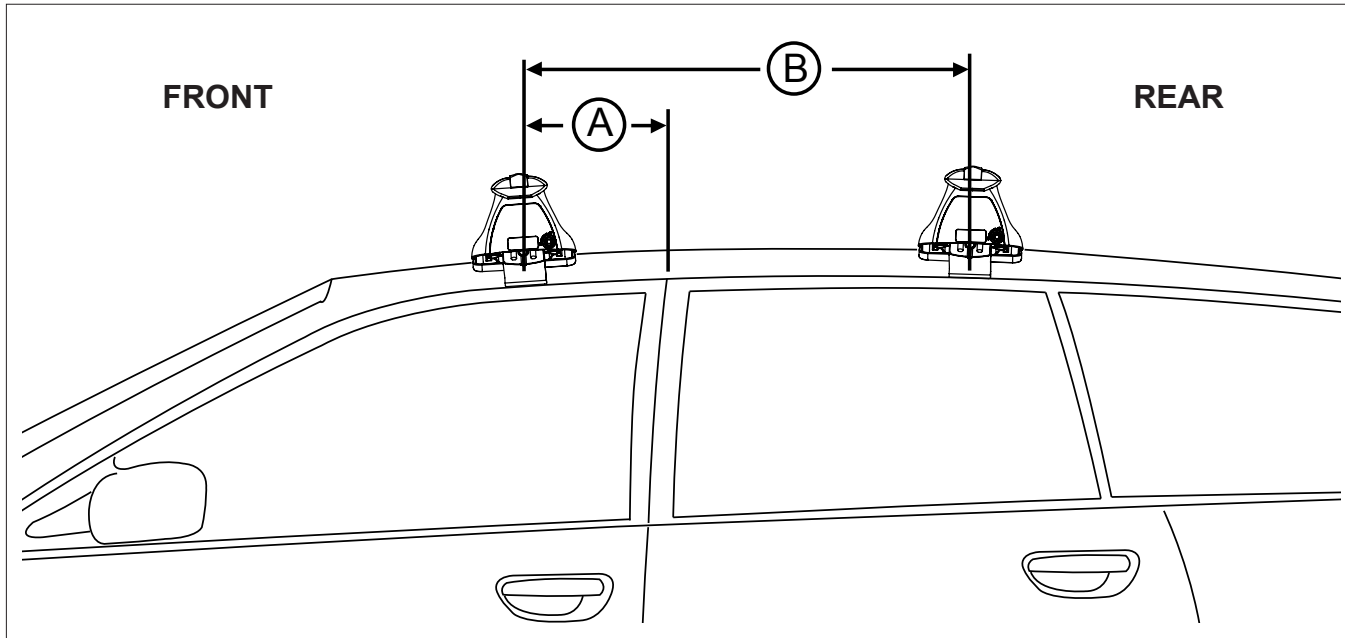

VEHICLE	Date	Measurement A	Measurement B	Load Rating (includes racks 5kg/ 11lbs)
Honda Pilot 3rd Gen	2016 -	200mm / 7,7/8"	800mm / 31,1/2"	75kg / 165lbs