

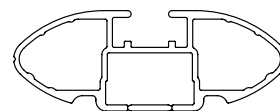

CROSSBAR IDENTIFICATION

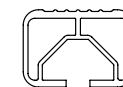





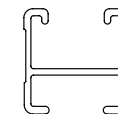

VA crossbar

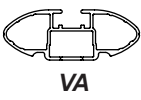

EURO crossbar

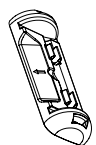
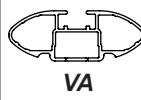

HD crossbar

			FRONT CROSSBAR					REAR CROSSBAR						
														
Vehicle	Date	Crossbar	Front Right Pad/Clamp	Front Left Pad/Clamp	Measurement strip length per side	Measurement strip length per side	Measurement Distance (x)	Foot plate arrow direction	Rear Right Pad/Clamp	Rear Left Pad/Clamp	Measurement strip length per side	Measurement strip length per side	Measurement Distance (x)	Foot plate arrow direction
Acura RDX 4dr SUV (TB3/TB4) Gen 2	13-18	1375mm	142649 SUB0370	142650 SUB0370	165mm	110mm	1093mm / 43, 1/32"	OUT	M504 SUB0261	M503 SUB0261	130mm	75mm	1023mm / 40,9/32"	OUT
			Pad Arrow Out						Pad Arrow IN					
Acura RDX 4dr SUV (TC1/TC2) Gen 3	19-	1375mm	142649 SUB0370	142650 SUB0370	179mm	124mm	1121mm / 44, 1/8"	OUT	M504 SUB0261	M503 SUB0261	150mm	95mm	1063mm / 41, 7/8"	OUT
			Pad Arrow OUT						Pad Arrow IN					



Rhino Rack 2500 Series - DK337 instruction

CONTROLLED

Measurement A: CENTRE of door jamb to CENTRE arrow of leg foot plate.

Measurement B: CENTRE of Front leg foot plate arrow to CENTRE of Rear leg foot plate arrow.

Carrying capacity: Roof rack is rated to 75kg. Please refer to manufacturers handbook for your vehicles maximum roof load capacity. Always use the lower of the two figures.

If your vehicle is not listed on this fitting instruction please refer to your countries Rhino-Rack web site for the latest information.

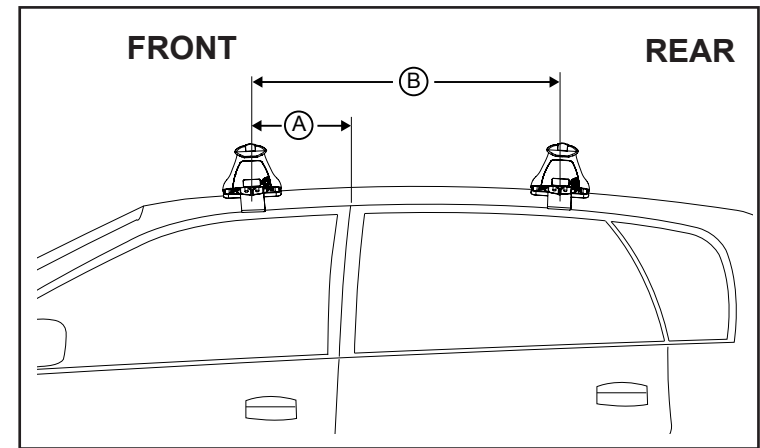
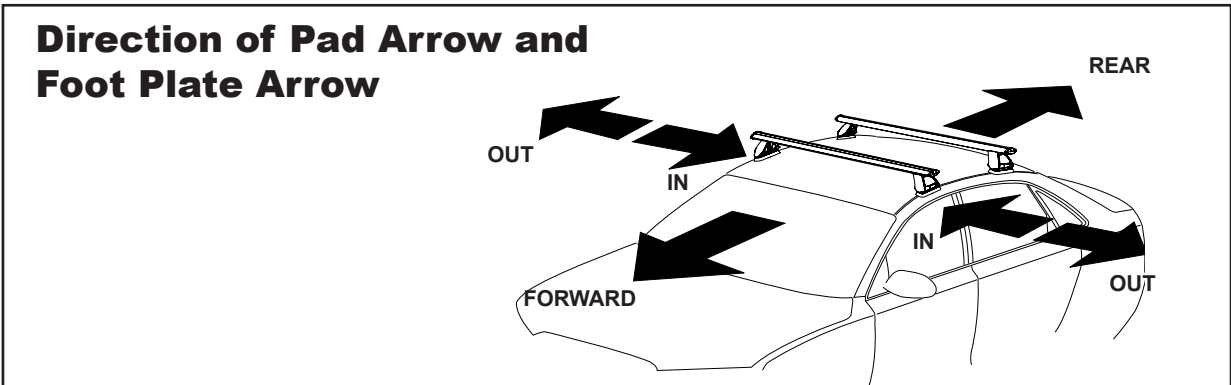
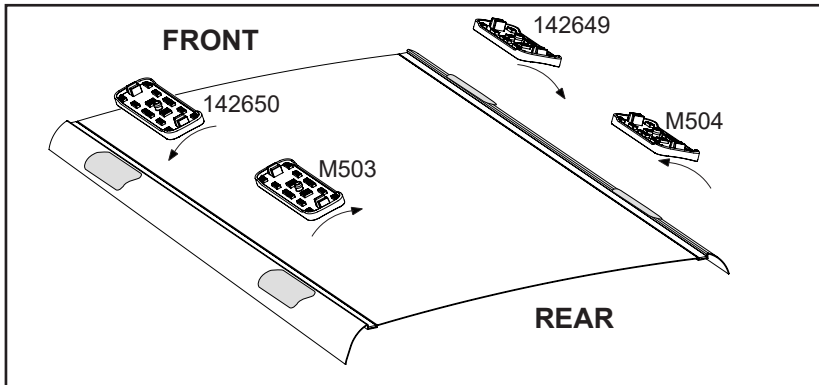

VEHICLE	Date	Measurement A	Measurement B	Load Rating (includes racks 5kg/ 11lbs)
Acura RDX 4dr SUV (TB3/TB4) Gen 2	13-18	220mm / 8,21/32"	700mm / 27,9/16"	75kg / 165lbs
Acura RDX 4dr SUV (TC1/TC2) Gen 3	19 on	150mm / 5, 15/16"	700mm / 27,9/16"	75kg / 165lbs