

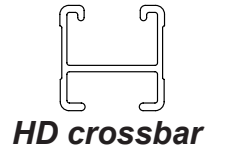

DK334 Rhino-Rack VA, Aero, Euro & HD crossbar instruction

IDENTIFICATION CHART

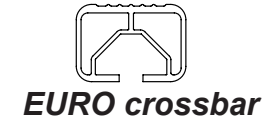
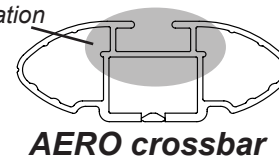
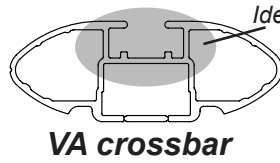

FRONT CROSSBAR

REAR CROSSBAR

Vehicle	Date	Crossbar	FRONT CROSSBAR					REAR CROSSBAR						
			Front Right Pad/ Clamp	Front Left Pad/ Clamp	Measurement strip length per side	Measurement strip length per side	Measurement Distance (x)	Foot plate arrow direction	Rear Right Pad/ Clamp	Rear Left Pad/ Clamp	Measurement strip length per side	Measurement strip length per side	Measurement Distance (x)	Foot plate arrow direction
KIA Rio UB 4dr Sedan	02/2012-	1260mm	M366 SUB0264		182mm	69mm	1012mm / 39,27/32"	OUT	M367 SUB0151		150mm	37mm	948mm / 37,21/64"	OUT
			Arrow FORWARD						Arrow FORWARD					



DK334 Rhino-Rack VA, Aero, Euro & HD crossbar instruction

Measurement A: CENTRE of door jamb to CENTRE arrow of leg foot plate.

Measurement B: CENTRE of Front leg foot plate arrow to CENTRE of Rear leg foot plate arrow.

Carrying capacity: Roof rack is rated to 75kg. Please refer to manufacturers handbook for your vehicles maximum roof load capacity. Always use the lower of the two figures.

If your vehicle is not listed on this fitting instruction please refer to your countries Rhino-Rack web site for the latest information.

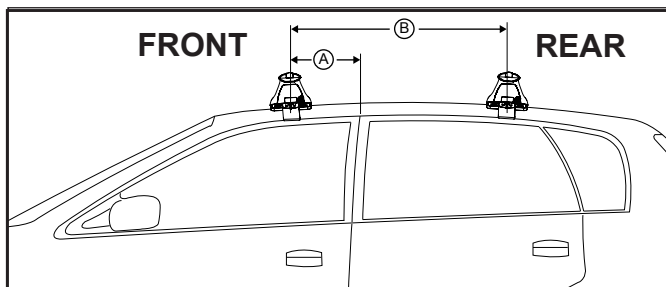
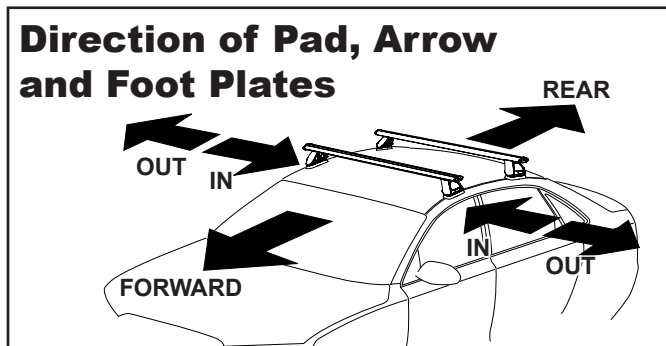
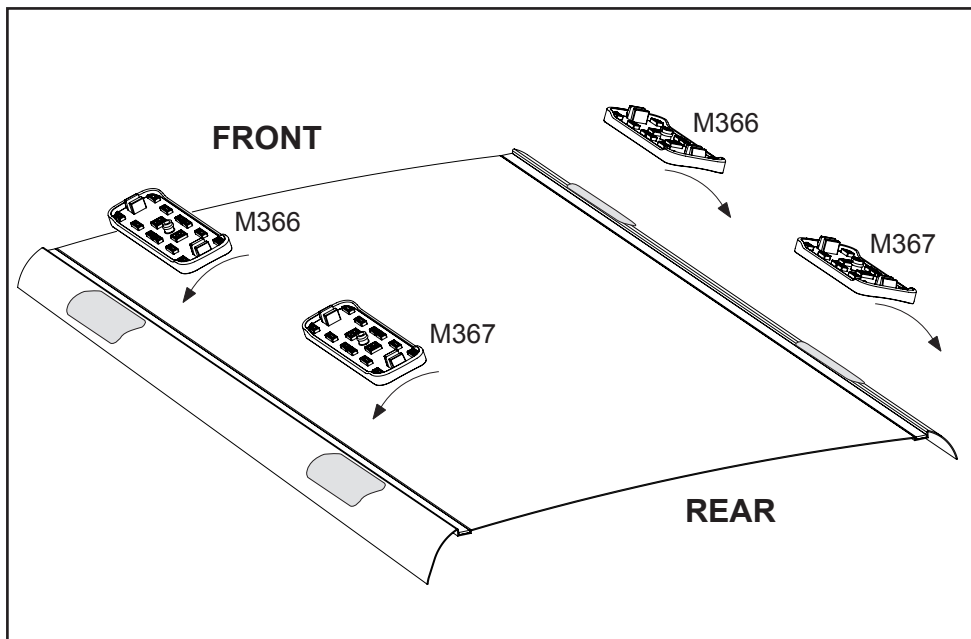

VEHICLE	Date	Measurement A	Measurement B	Load Rating (includes racks 5kg/ 11lbs)
KIA Rio UB 4dr Sedan	02/2012-	300mm / 11,13/16"	650mm / 25,19/32"	75kg / 165lbs