

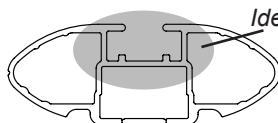

# DK280 Rhino-Rack VA, Aero, Euro & HD crossbar instruction

## IDENTIFICATION CHART



VA crossbar

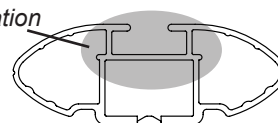

AERO crossbar



EURO crossbar

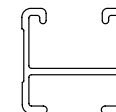

HD crossbar

### FRONT CROSSBAR

### REAR CROSSBAR

Vehicle	Date	Crossbar	FRONT CROSSBAR					REAR CROSSBAR						
			Front Right Pad/ Clamp	Front Left Pad/ Clamp	Measurement strip length per side	Measurement strip length per side	Measurement Distance ( x )	Foot plate arrow direction	Rear Right Pad/ Clamp	Rear Left Pad/ Clamp	Measurement strip length per side	Measurement strip length per side	Measurement Distance ( x )	Foot plate arrow direction
Honda Odyssey RB 4dr wagon	04/2009-	1260mm	M506 SUB0370	M505 SUB0370	200mm	87mm	1048mm / 41,1/4"	OUT	M506 SUB0261	M505 SUB0261	173mm	60mm	994mm / 39,1/8"	OUT
			Arrow OUT						Arrow OUT					



# DK280 Rhino-Rack VA, Aero, Euro & HD crossbar instruction

**Measurement A:** CENTRE of door jamb to CENTRE arrow of leg foot plate.

**Measurement B:** CENTRE of Front leg foot plate arrow to CENTRE of Rear leg foot plate arrow.

**Carrying capacity:** Roof rack is rated to 75kg. Please refer to manufacturers handbook for your vehicles maximum roof load capacity. Always use the lower of the two figures.

If your vehicle is not listed on this fitting instruction please refer to your countries Rhino-Rack web site for the latest information.

- Pad M505 FRONT Left of vehicle - Arrow facing outward.
- Pad M506 FRONT Right of vehicle - Arrow facing outward.
- Pad M506 REAR Right of vehicle - Arrow facing outward.
- Pad M505 REAR Left of vehicle - Arrow facing outward.

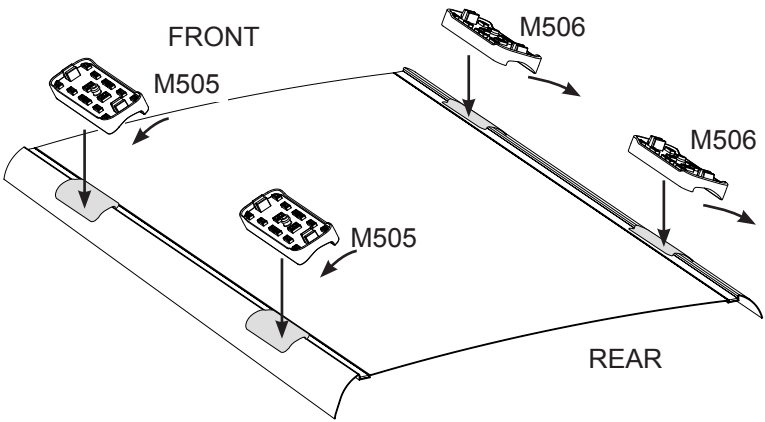

Front Right Pad M506

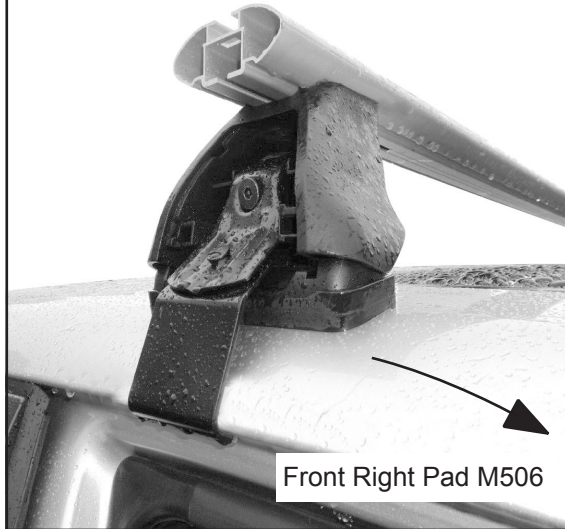

### Direction of Pad, Arrow and Foot Plates

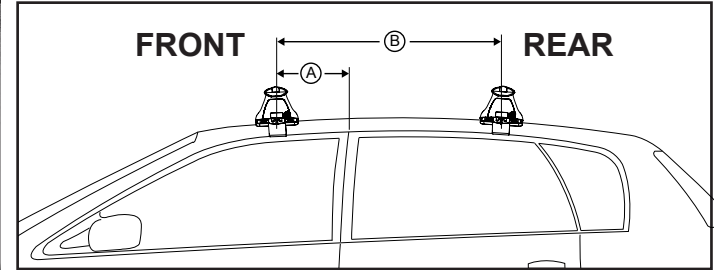
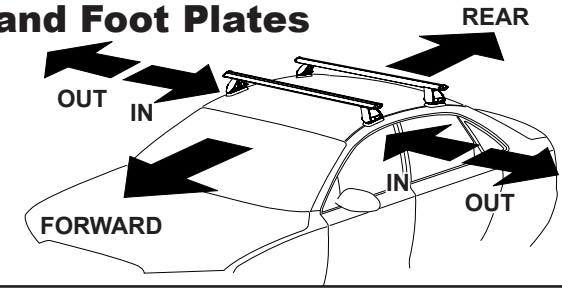

VEHICLE	Date	Measurement A	Measurement B	Load Rating (includes racks 5kg/ 11lbs)
Honda Odyssey RB 4dr wagon	04/2009-	130mm / 5,1/8"	700mm / 27,9/16"	40kg / 88lbs