



# RHINO-RACK

CONTROLLED

## Euro Bar Adaptor Kit EB-FK2

To be used with ROC25 Leg and Steel Euro Bar ONLY

**A** x4

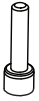

**B** x4

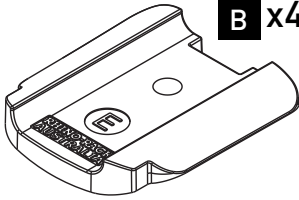

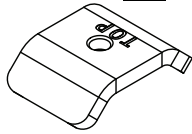

**C** x4



Item	Description	Qty
A	M6 x 30mm cap screw	4
B	ROC25 euro bar adaptor	4
C	M6 channel nut - suit steel euro bar	4
D	Instruction	1

### 1 - Calculating underbar strip

For Steel Euro Bar  underbar strip, refer to the vehicles DK specific sheet and use the VA Bar  measurement.

**Do not use the Alloy Bar or Euro Bar measurement** .

### EXAMPLE

Rhino Rack 2500 Series - OK497

Vehicle	Chassis	ROVY CROSSBAR		BAR CROSSBAR	
		Front	Rear	Front	Rear
Via Centro (4x4)	1180mm	M604 / 1020mm / 38 1/2"	M623 / 1020mm / 38 1/2"	M608 / 1020mm / 38 1/2"	M627 / 1020mm / 38 1/2"
Via Forte, EC (4x4)	1180mm	M604 / 1020mm / 38 1/2"	M623 / 1020mm / 38 1/2"	M608 / 1020mm / 38 1/2"	M627 / 1020mm / 38 1/2"

Example:  
1 - Note VA measurement length.  
2 - Cut underbar strip to 213mm.

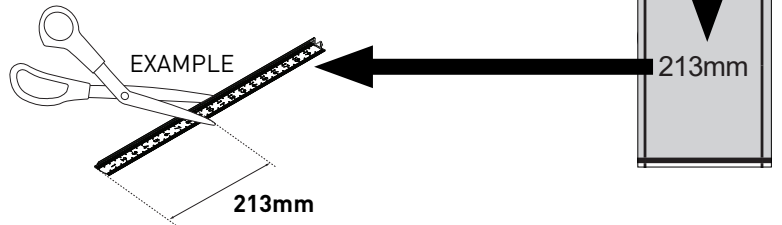

**2**

Underbar strip

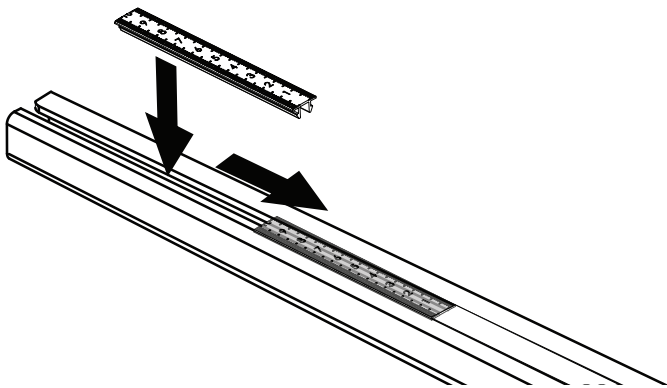

**3**

"Top" marking to face upward.

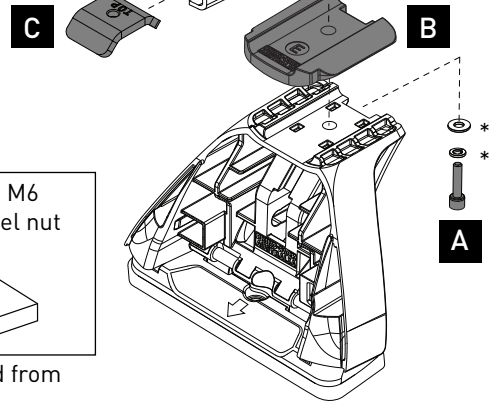

Note: Discard M6 square channel nut from leg kit.

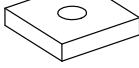

\*Washers used from leg kit.

**4**

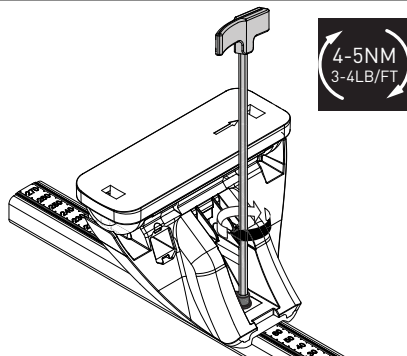

4-5NM  
3-4LB/FT