

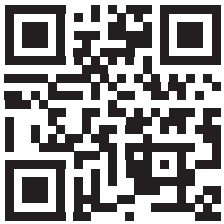



VEHICLE		BAR TYPE		CONNECTOR		BED HEIGHT ADDED (mm/in)		
JEEP Gladiator JT 6ft4		Reconn-Deck		RTD4		280/11		
VEHICLE NOTES								
REGION	AUS	NZ	USA	CA	SA	UK	EU	ZA
AVAILABILITY	✓	✓	✓	✓	x	x	x	x
RUNNING DATES	2020 -	2020 -	2020 -	2020 -	-	-	-	-

VISIT THE ONLINE CALCULATOR FOR CURRENT SYSTEM LOAD LIMIT DATA

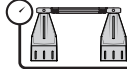

**DYNAMIC LOAD LIMIT (ON AND OFF-ROAD):**  
 \*USE THE VEHICLE MANUFACTURER'S MAXIMUM TRACK ALLOWANCE IF IT IS LOWER THAN THE FIGURE LISTED

 CARGO	 SYSTEM WEIGHT	 LOAD LIMIT
UP TO <b>123 Kg</b> <b>272 lbs</b>	<b>+</b> <b>27 Kg</b> <b>59 lbs</b>	<b>=</b> UP TO <b>150 Kg</b> <b>331 lbs</b>

**OR**  **\*VEHICLE MANUFACTURER'S TRUCK BED UTILITY TRACK LOAD LIMIT**

 **TOTAL STATIC LOAD LIMIT: UP TO 375kg / 827lbs**

### BASE

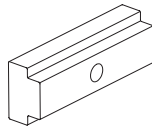
TRACK NUTS	PART DETAILS	
	<b>PART NO</b>	RD-FK1
	<b>KIT QTY</b>	1

### BAR

CROSS BAR	PART DETAILS	
	<b>PART NO</b>	RDB150
	<b>QTY</b>	2

### ACCESSORY

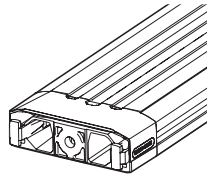
NS BAR	PART DETAILS	
	<b>PART NO</b>	RDNSB75
	<b>QTY (pair)</b>	3
	Recommended NS Bar setup is included in the SYSTEM WEIGHT above. Refer to NS BAR Instructions for custom setups.	

ONLY COMPATIBLE WITH RECONN-DECK BARS

### RECOMMENDED TOWER SPACING

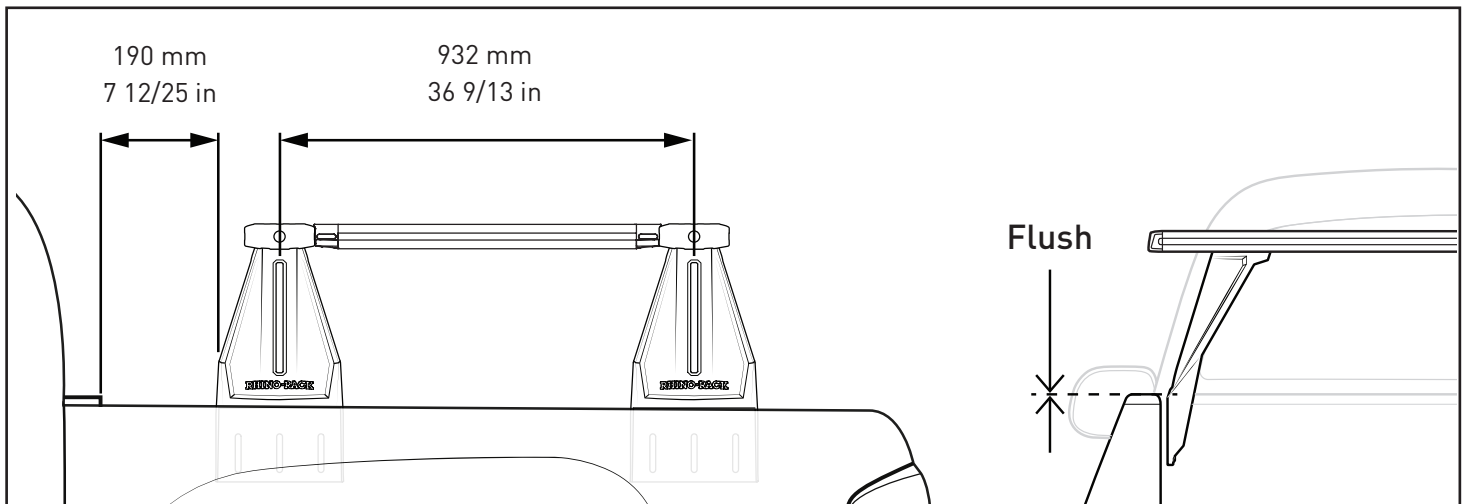

After positioning Towers, return to NS bar Instructions.

### NOTES FOR DEALERS / FITTERS

It is your responsibility to ensure these fitting instructions are given to the end user or client.

Document No: R2997  
 Issue No: 1  
 Issue Date: 25-Oct-21