

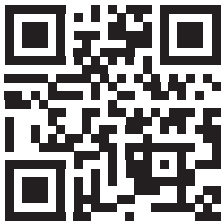





VEHICLE		BAR TYPE		CONNECTOR		BED HEIGHT ADDED (mm/in)		
JEEP Gladiator JT 6ft4		Vortex		RTD4		280/11		
VEHICLE NOTES								
REGION	AUS	NZ	USA	CA	SA	UK	EU	ZA
AVAILABILITY	✓	✓	✓	✓	x	x	x	x
RUNNING DATES	2020 -	2020 -	2020 -	2020 -	-	-	-	-

VISIT THE ONLINE CALCULATOR FOR CURRENT SYSTEM LOAD LIMIT DATA



DYNAMIC LOAD LIMIT (ON AND OFF-ROAD):
 *USE THE VEHICLE MANUFACTURER'S MAXIMUM TRACK ALLOWANCE IF IT IS LOWER THAN THE FIGURE LISTED

 CARGO UP TO 89 Kg 197 lbs	 SYSTEM WEIGHT 11 Kg 23 lbs	 LOAD LIMIT UP TO 100 Kg 220lbs	  *VEHICLE MANUFACTURER'S TRUCK BED UTILITY TRACK LOAD LIMIT
--	---	--	--

TOTAL STATIC LOAD LIMIT: UP TO 250kg / 551lbs

BASE

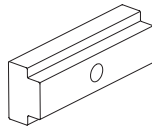
TRACK NUTS	PART DETAILS	
	PART NO	RD-FK1
	KIT QTY	1

BAR

CROSS BAR	PART DETAILS	
	PART NO	VA150B
	QTY	2

ACCESSORY

NS BAR	PART DETAILS	
	PART NO	-
	QTY (pair)	-
	Recommended NS Bar setup is included in the SYSTEM WEIGHT above. Refer to NS BAR Instructions for custom setups.	

ONLY COMPATIBLE WITH RECONN-DECK BARS

RECOMMENDED TOWER SPACING

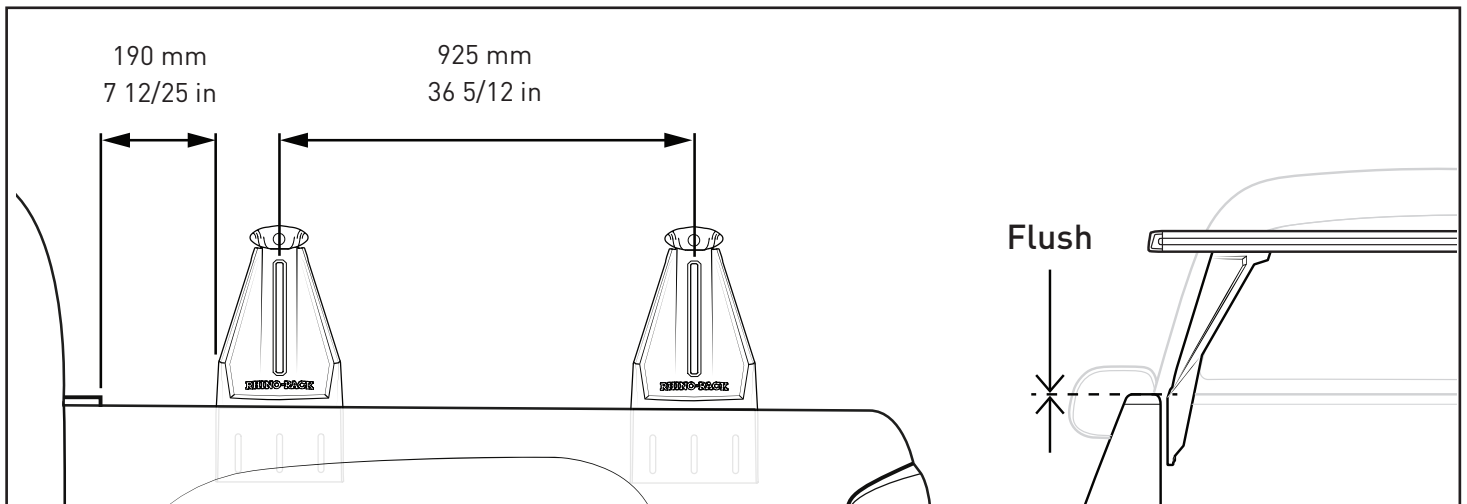

After positioning Towers, return to Reconn-Deck Tower Instruction.

NOTES FOR DEALERS / FITTERS

It is your responsibility to ensure these fitting instructions are given to the end user or client.