

VEHICLE		PIONEER		CONNECTOR		TRAY HEIGHT ADDED (mm/in)		
TOYOTA Tacoma Double Cab Gen 3 SHORT BED 5ft		52113		RTD4		298/12		
VEHICLE NOTES								
REGION	AUS	NZ	USA	CA	SA	UK	EU	ZA
AVAILABILITY	x	x	✓	✓	x	x	x	x
RUNNING DATES	-	-	2016-	2016-	-	-	-	-

VISIT THE ONLINE CALCULATOR FOR CURRENT SYSTEM LOAD LIMIT DATA



DYNAMIC LOAD LIMIT (ON AND OFF-ROAD):
 *USE THE VEHICLE MANUFACTURER'S MAXIMUM TRACK ALLOWANCE IF IT IS LOWER THAN THE FIGURE LISTED

 CARGO
 UP TO **90 Kg**
199 lbs

+

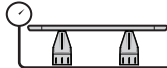
 SYSTEM WEIGHT
 UP TO **30 Kg**
66 lbs

=



 LOAD LIMIT
 UP TO **120 Kg**
265 lbs

OR

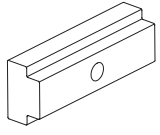

 Max kg
 *VEHICLE MANUFACTURER'S TRUCK BED UTILITY TRACK LOAD LIMIT

TOTAL STATIC LOAD LIMIT: UP TO 300 Kg / 661 lbs*

BASE

TRACK NUTS	
	
PART DETAILS	
PART NO	RD-FK1
QTY	1

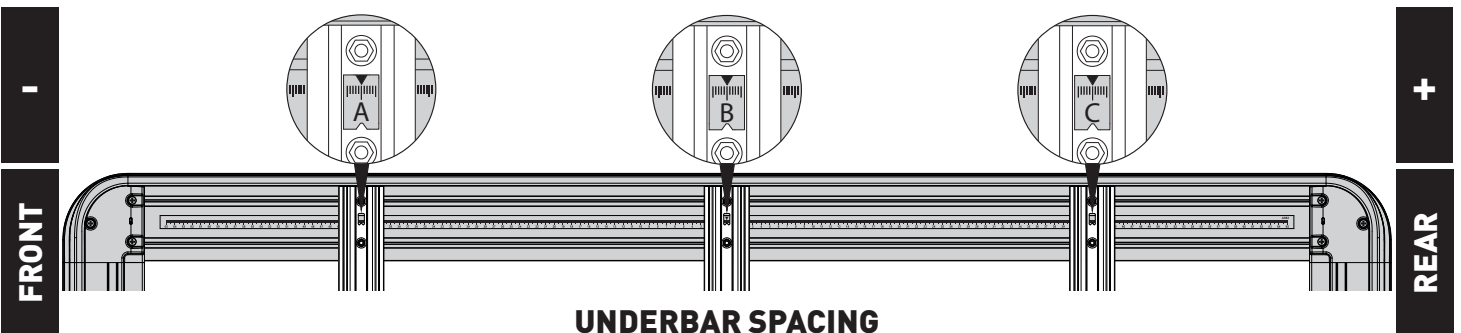
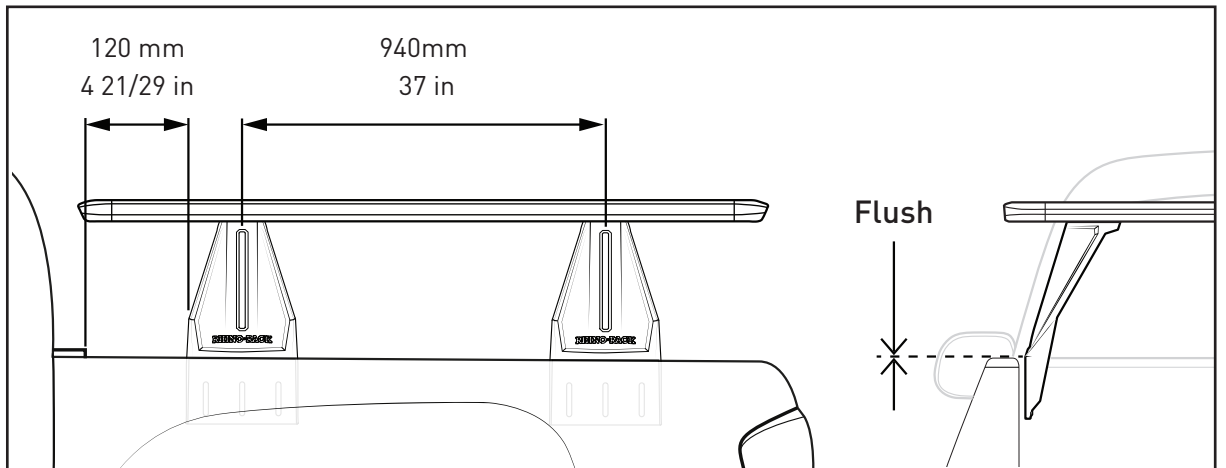
RECOMMENDED TOWER SPACING



BAR NO.	A	B	C	D	E	F	G
DIMENSION (CM)	-54	0	40				
CONNECTOR	RDT		RDT				

After positioning Towers and Pioneer, return to Reconn-Deck Tower Instructions.

NOTES FOR DEALERS / FITTERS

It is your responsibility to ensure these fitting instructions are given to the end user or client.

Document No: R2789
 Issue No: 1
 Issue Date: 12-May-21