

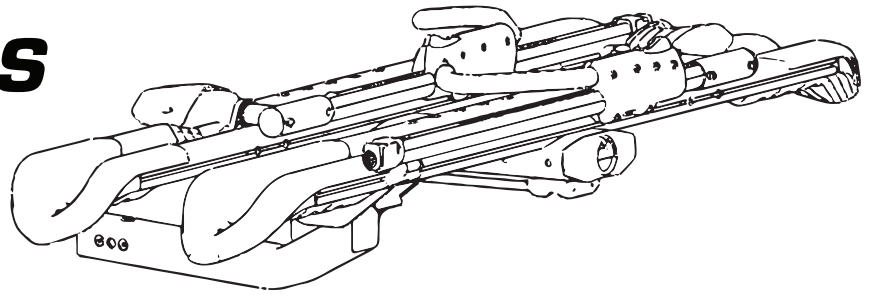

rockymounts SplitRail LS



Guidelines

- Carries 2 bikes, up to 60lbs (27kg) each [120lbs (54kg) total]
- Expandable to 3 or 4 bikes up to 45lbs (21kg) each , with Add-Ons
- Tire Width: 19mm road bike tires - 3.0" mountain bike tires
- Wheel Diameter: 20" - 29"
- Wheelbase: 34" - 50"
- Remove front fenders, racks, and panniers before use
- No kick bikes, recumbents, mopeds, scooters, pennyfarthings, or tandems

Parts Included

A: Wheel tray A
B: Load arm A
C: Wheel tray B
D: Load arm B

E: Base: 2"
F: Hitch pin with lock pod
G: 19mm wrench
H: Garage storage hook (1x)

I: 6mm long handle hex wrench
J: 5mm hex wrench
K: Bolt M8 x 45mm with washers (8x)
L: Bolt M6 x 60mm (8x)

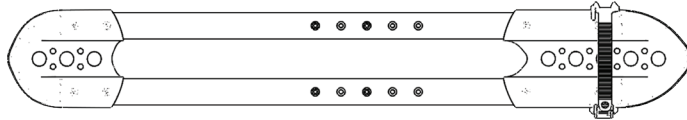

A (1x)

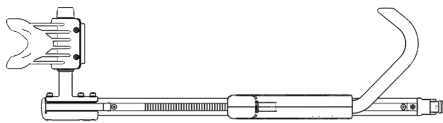

B (1x)

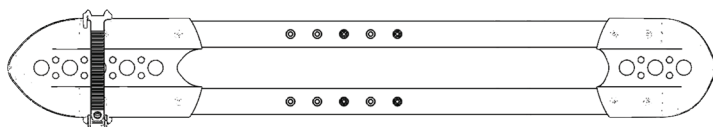

C (1x)

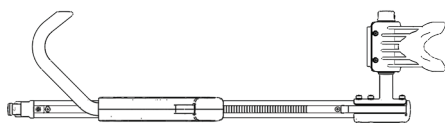

D (1x)

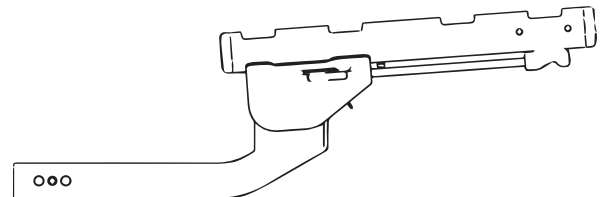

E (1x)



F (1x)

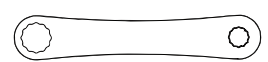

G (1x)

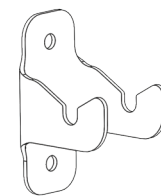

H (1x)

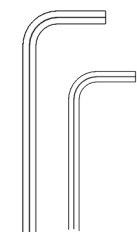

I (1x)



J (1x)



K (8x)



L (8x)

Read all warnings on last page before use. **rockymounts™**

Assembly Instructions

1 Install Hitch Pin

Insert hitch tube into vehicle hitch receiver. Install hitch pin from passenger side, and install lock pod. Hitch Pin must be at least 1.5" from end of receiver

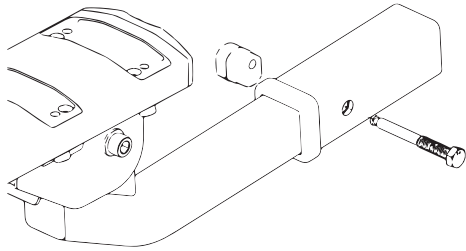

2 Install Wheel Tray A

Place wheel tray A onto base with short wheel cup on driver side. Wheel strap buckle should be face out for easier access. Align holes closest to short wheel cup with holes on left side of base and install for M8x45 bolts and washers.

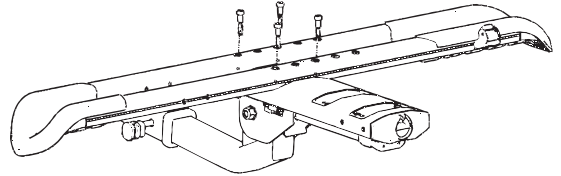

3 Install Wheel Tray B

Repeat steps for wheel tray B with shorter wheel cup on passenger side and holes farthest to the right aligned.

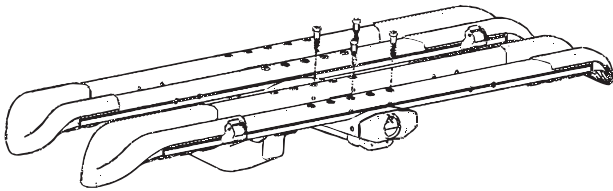

4a Install Load Arms

Install load arm A onto wheel tray A using four M6x60 bolts with 5mm hex wrench. Bolts should pass through reinforcement plate (see step #4b). Load arm should face out for easier access.

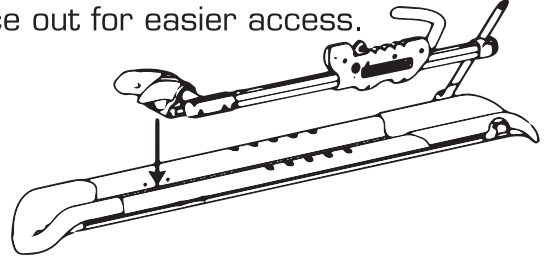

4b Install Load Arms

Repeat steps for load arm B. Bolts should pass through reinforcement plate. Load arm should face out for easier access.

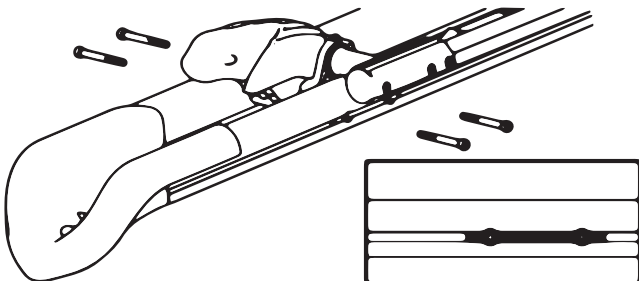

5 Removing Rack

Unlock and remove hitch pin and lock pod.

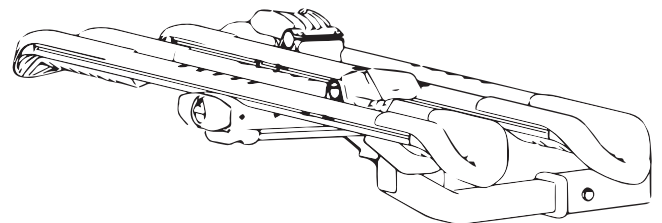

Assembly Instructions

6 Rack Positions

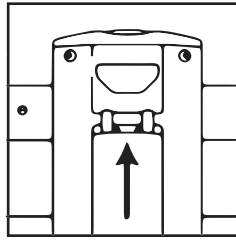
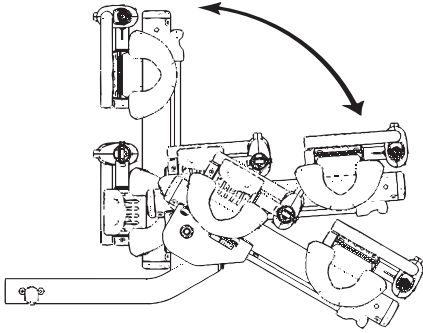

Gently release handle to raise and lower rack into stow, use, and tilt positions.

Rack can be folded into stowed position when not in use and tilted down for rear vehicle access

Load arms should be stowed flat when rack is not in use.

Release handle should be fully seated before each use.

Loading Instructions

1 Open Load Arm

Rotate load arm 180 degrees from stowed position and fully extend hook. Loop wheel strap back and catch on plastic tab

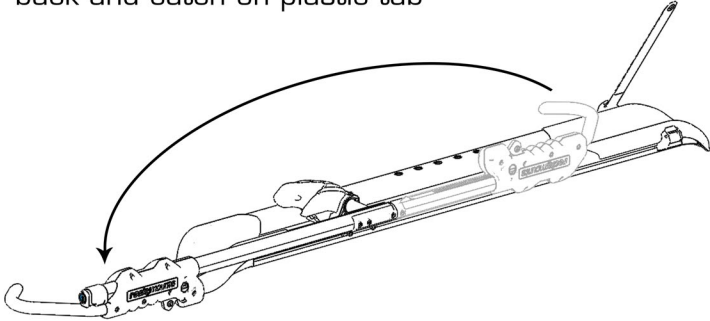

2 Place Bike on Rack

Load heaviest bike on tray nearest to vehicle. Front wheel should be secure against back stop

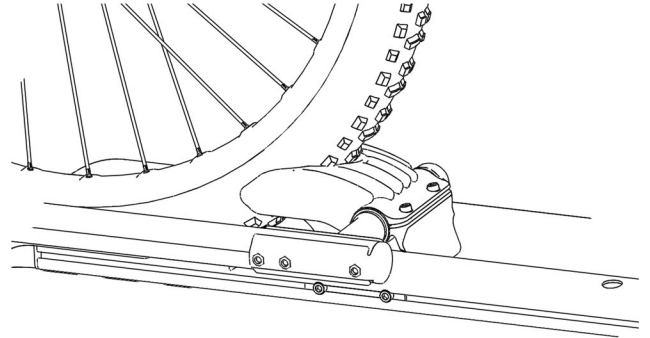

3 Secure Front Wheel

Rotate load arm over front wheel and tighten hook with minimal gap between fork

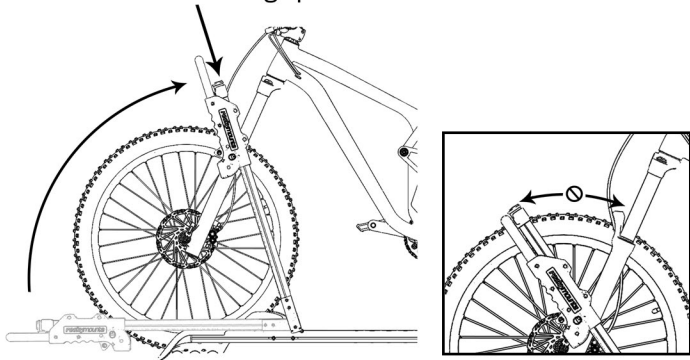

4 Secure Rear Wheel

Feed rear wheel strap through rear wheel and into buckle. Pull tight. Slide strap forward for low profile rims

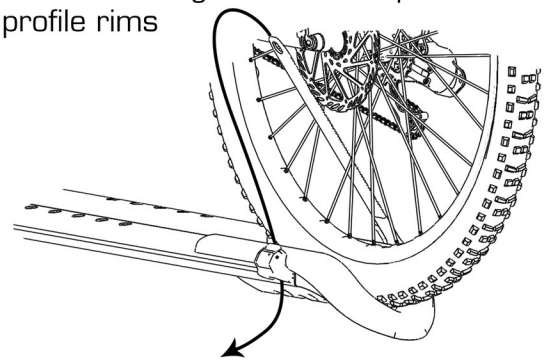

5 Locking Bikes

Pull cable lock out from top of load arm

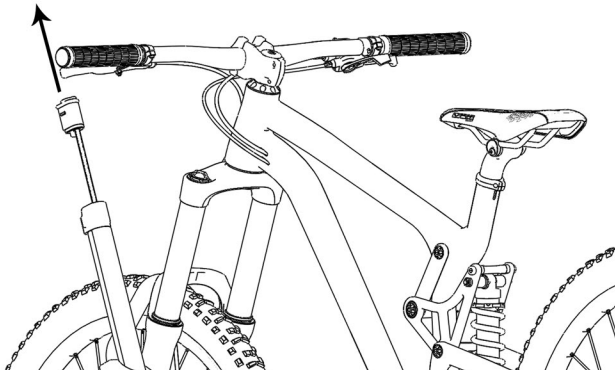

6 Cable Lock

Feed cable through bike frame and lock cable to metal boss

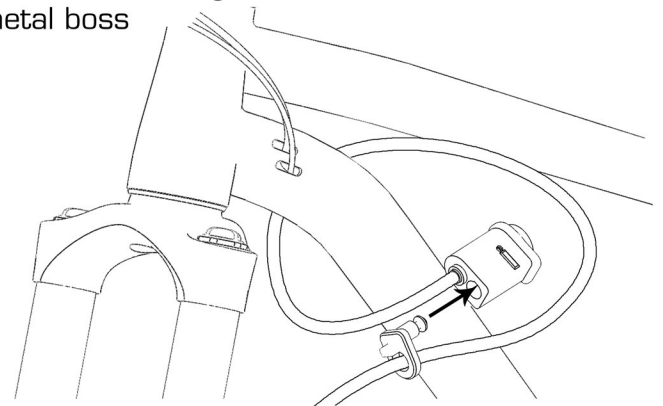

Read all warnings on last page before use. **rockymounts™**

Rack Adjustability

1 Remove Trays

Trays can be adjusted side-to-side to avoid handlebar interference. Remove bikes and fold rack into use position. Remove eight M8 bolts from trays.

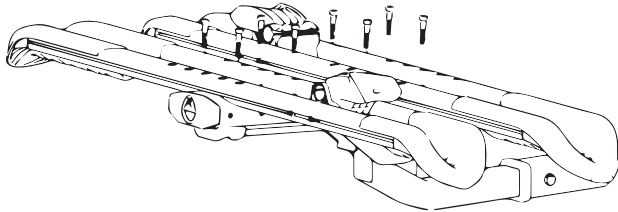

2 Adjust Trays

Slide trays to line up appropriate holes for amount of adjustment needed. Reinstall eight M8 bolts into new holes.

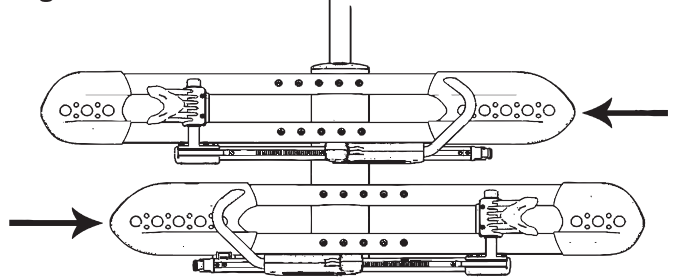

3 Check Mirrors

Be sure loaded bikes do not extend past width of side view mirrors.

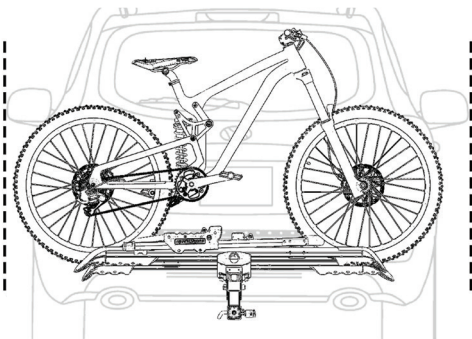

Wall Mount

1 Installation

Position wall mount at least 36" (92cm) off floor. Wall mount must be installed securely into stud. we recommend 5/16" x 3" lag bolt.

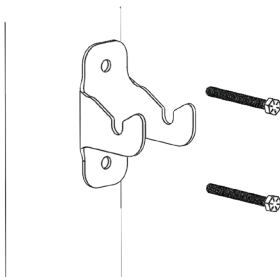

2 Use

Install hitch pin and lock pod into rack. Fold rack into use position. Hang rack on wall mount hook using hitch pin.

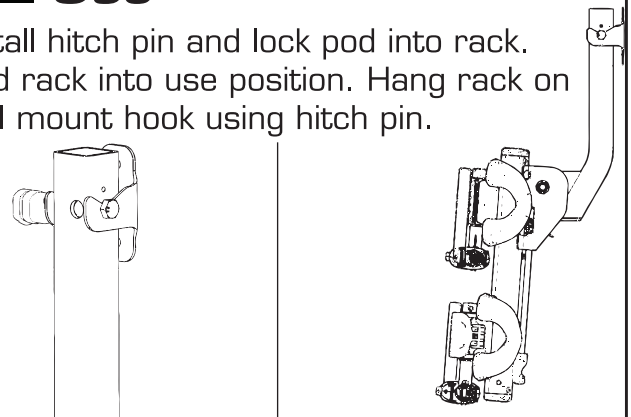

Read all warnings on last page before use. **rockymounts™**

Warnings

- If a hitch extension is needed, only anti-wobble hitch extensions by RockyMounts™ can be used with this product
- Remove Baby Seats, Panniers, U-Locks, or Items That Could Detach From The Bicycle
- Do not use bicycle covers, bicycle bras, or equipped with rear disc wheel
- Not intended for off road use. Not intended for use on trailers or towed vehicles
- Not intended for use with trailers, towed vehicles, 1 ton pickups, RV's, or UHV/UTVs
- Bikes and rack can partially block license plate and/or taillights. Please check and adjust accordingly
- Check the car exhaust is not pointing at the rack, bike tires, or rims. Some vehicles may require exhaust diversion to avoid damage
- Do not transport bikes with flat or leaking front tires. Front tire must be inflated for secure transport
- Hitch pin holes need to be a minimum of 1.5" (38mm) from end of hitch receiver
- Locks are only deterrents for thieves, RockyMounts™ Inc. Cannot be held liable for stolen bicycles
- Check All Fasteners Before Each Use
- Remove Bikes and Rack Before Entering Car Wash
- Once a Year, Remove From Car to Clean and Inspect for Damage
- Only open rack when vehicle is parked on level ground. Locking handle must be tightened and rack must be secured before driving

Limited Lifetime Warranty

At RockyMounts™ we offer a Limited Lifetime Warranty for products purchased after January 1, 2014 to the original owner. For details of the Warranty, guidelines, and how to make a claim please see rockymounts.com/warranty

Technical Support

Please call us at 303-402-0190 or email at ride@rockymounts.com for questions regarding use, assembly, and support