

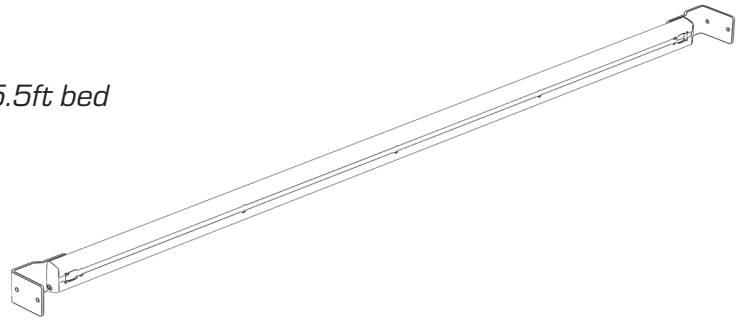

rockymounts™

60" Track

for 2009-Current Ford F-150 with 5.5ft bed



Guidelines

- Maximum weight: 60 lb per bike
- Compatible with RockyMounts™ DriveShaft Track, HotRod and LoBall series bike mounts
- After loading a bicycle, shake fork side to side to ensure assembly is tight and secure
- Not recommended for use on trailers
- Not intended for offroad use
- Trimming may be required for trucks with spay-on bedliners

Parts Included

A: 60" Track w/ End Caps

B: Mounting Bracket

C: M8x16 Allen Bolt

D: M8 Flat Washer

E: M6x30 Allen Bolt

F: M6 Allen Wrench

G: M6 Flat Washer

H: M6 Hex Nut

I: M5 Allen Wrench

J: M6x18 Allen Bolt

K: Track Plate

L: T30 Torx Wrench

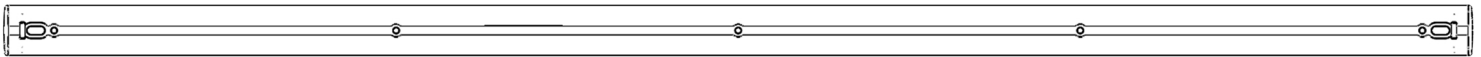

A (1x)

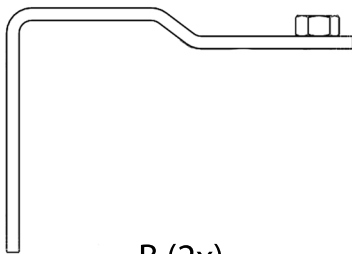

B (2x)



C (2x)



D (2x)



E (5x)



G (10x)



H (5x)

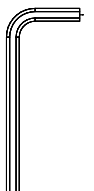

I (1x)



J (4x)

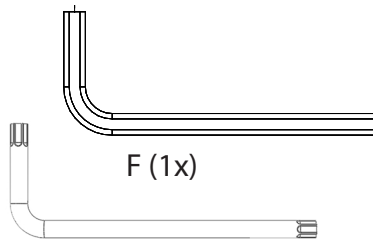

F (1x)

L (1x)



G (4x)



J (4x)

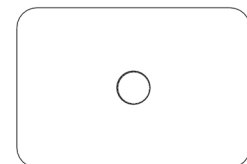

K (4x)



G (4x)

Read all warnings on last page before use.

rockymounts™

Assembly Instructions

1 Install Mounting Brackets

Unscrew M6 bolts and remove each front tie down cleat using T30 torx wrench. Reinstall each tie down cleat over a mounting bracket with two M6x30 Allen bolts and two M6 washers, using M5 Allen wrench.

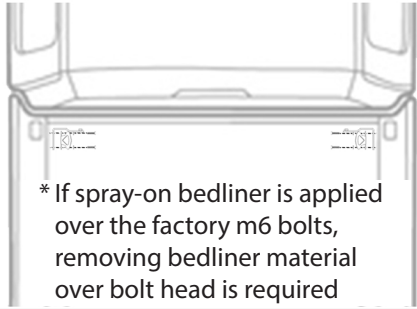
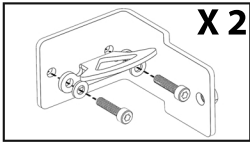
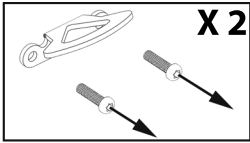

* If spray-on bedliner is applied over the factory m6 bolts, removing bedliner material over bolt head is required

2 Install Bike Mounts¹

Press tabs on end caps and pull out. loosely install track hardware² onto bike mounts. Slide bike mounts onto track.

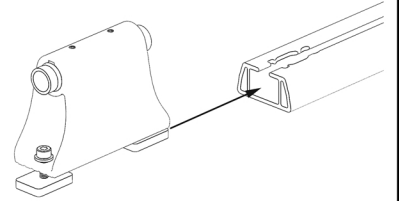
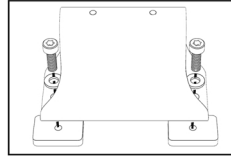
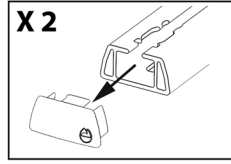

3 Install Track

Reinstall two end caps. Install track to mounting brackets using an M8x16 Allen bolt with an M8 washer on each side.

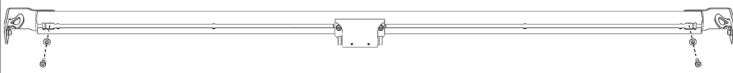
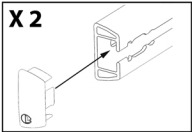

4 Tighten Bike Mounts

Slide bike mounts to desired location and tighten all bolts. Bike mounts should be secure and not move after tightened

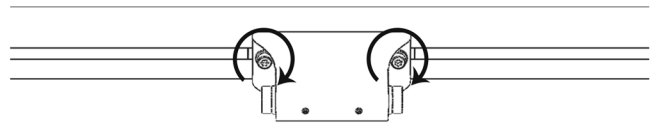

1. Bike mounts not included.

2. Track hardware provided: M6x18 Allen bolt (x4), M6 Flat Washer (x4), Track Plate (x4)

Warnings

Remove Baby Seats, Panniers, U-Locks, or items that could detach from bicycle.
Check all fastenings before each use.
Once a year, remove track from car. Clean and inspect for damage.
Remove bikes before entering a car wash.

Limited Lifetime Warranty

At RockyMounts™ we offer a Limited Lifetime Warranty for products purchased after January 1, 2014 to the original owner. For details of the Warranty, guidelines, and how to make a claim please see rockymounts.com/warranty

Technical Support

Please call us at 303-402-0190 or email at ride@rockymounts.com for questions regarding use, assembly, and support

Read all warnings on last page before use. **rockymounts™**