

VEHICLE	PIONEER			CONNECTOR			HEIGHT ADDED (mm/in)	
LEXUS LX470 4WD/SUV Raised Rail 4 dr	52101			SX100			110 / 4.3	
VEHICLE NOTES	- Do not operate sunroof							
REGION	AUS	NZ	USA	CA	SA	UK	EU	ZA
AVAILABILITY	✓	✓	✓	✓	✓	x	x	x
RUNNING DATES	1998 - 2021	1998 - 2021	1998 - 2007	1998 - 2007	1998 - 2007	-	-	-

VISIT THE ONLINE  
LOAD LIMIT  
CALCULATOR FOR  
CURRENT LOAD DATA



**DYNAMIC LOAD LIMIT (ON AND OFF-ROAD):**  
 \*USE THE VEHICLE MANUFACTURER'S MAXIMUM ROOF ALLOWANCE IF IT IS LOWER THAN THE FIGURE LISTED

  
 CARGO  
 UP TO **55 Kg**  
**121 lbs**

+

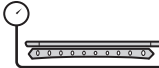
  
 SYSTEM WEIGHT  
 UP TO **25 Kg**  
**55 lbs**

=

  
 LOAD LIMIT  
 UP TO **80 Kg**  
**176 lbs**

**OR**

  
 Max kg  
 \*VEHICLE  
 MANUFACTURER'S  
 ROOF LOAD LIMIT

**TOTAL STATIC LOAD LIMIT: UP TO 200 Kg / 441 lbs\***

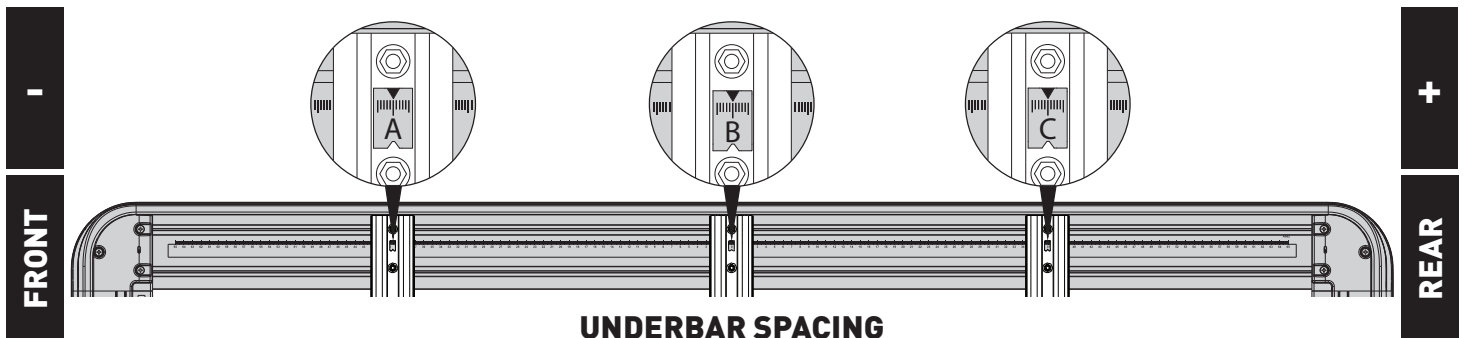

BAR NO.	A	B	C	D	E	F	G
DIMENSION (CM)	-45	0	44				
SPACERS REQ'D							
CONNECTOR	SX		SX				

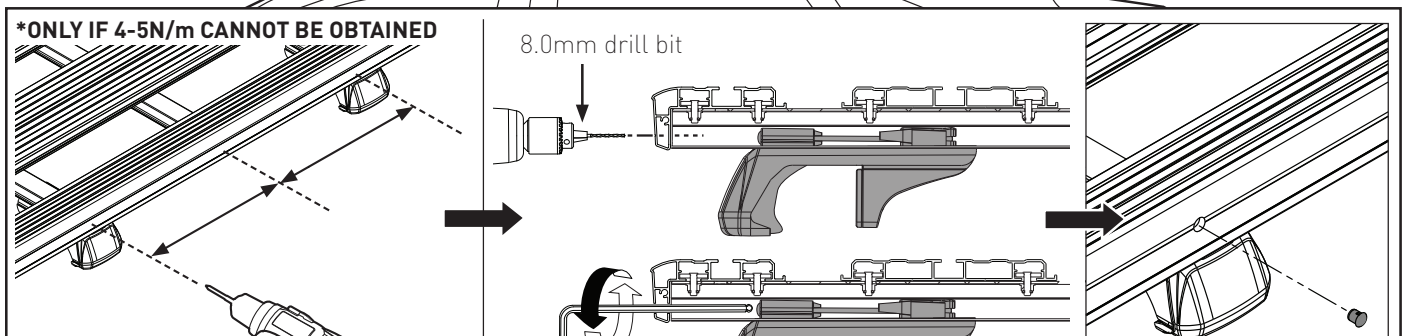
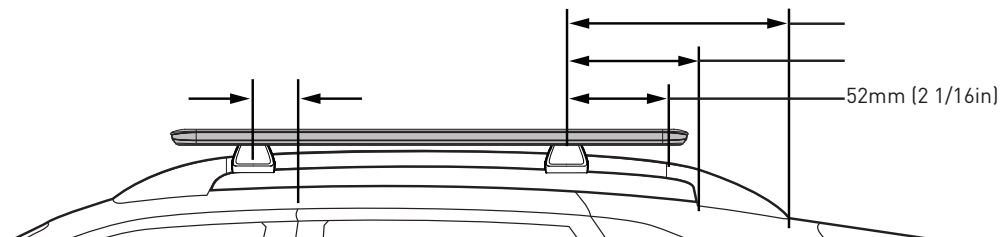

### NOTES FOR DEALERS / FITTERS

It is your responsibility to ensure these fitting instructions are given to the end user or client.

Document No: R2157  
 Issue No: 5  
 Issue Date: 19-Mar-21