

VEHICLE		PIONEER			CONNECTOR		HEIGHT ADDED (mm/in)	
TOYOTA Land Cruiser Prado 150 Series (SWB) 4WD/SUV Raised Rail 3 dr		52100			SX100			
VEHICLE NOTES	- Do not operate sunroof							
REGION	AUS	NZ	USA	CA	SA	UK	EU	ZA
AVAILABILITY	✓	✓	x	x	x	✓	✓	✓
RUNNING DATES	2009 -	2009 -	-	-	-	2009 -	2009 -	2009 -

VISIT THE ONLINE
LOAD LIMIT
CALCULATOR FOR
CURRENT LOAD DATA



DYNAMIC LOAD LIMIT (ON AND OFF-ROAD):
 *USE THE VEHICLE MANUFACTURER'S MAXIMUM ROOF ALLOWANCE IF IT IS LOWER THAN THE FIGURE LISTED

 CARGO
 UP TO **61 Kg**
134 lbs

+

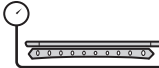

 SYSTEM WEIGHT
 UP TO **19 Kg**
42 lbs

=

 LOAD LIMIT
 UP TO **80 Kg**
176 lbs

OR

 Max kg
***VEHICLE
MANUFACTURER'S
ROOF LOAD LIMIT**

 **TOTAL STATIC LOAD LIMIT: UP TO 200 Kg / 441 lbs***

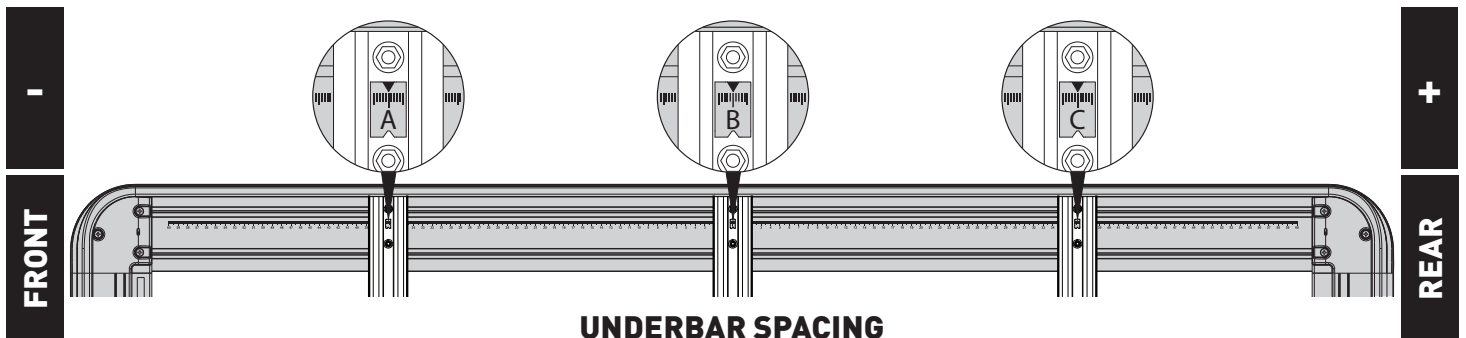

BAR NO.	A	B	C	D	E	F	G
DIMENSION (CM)	-33	0	33				
SPACERS REQ'D							
CONNECTOR	SX		SX				

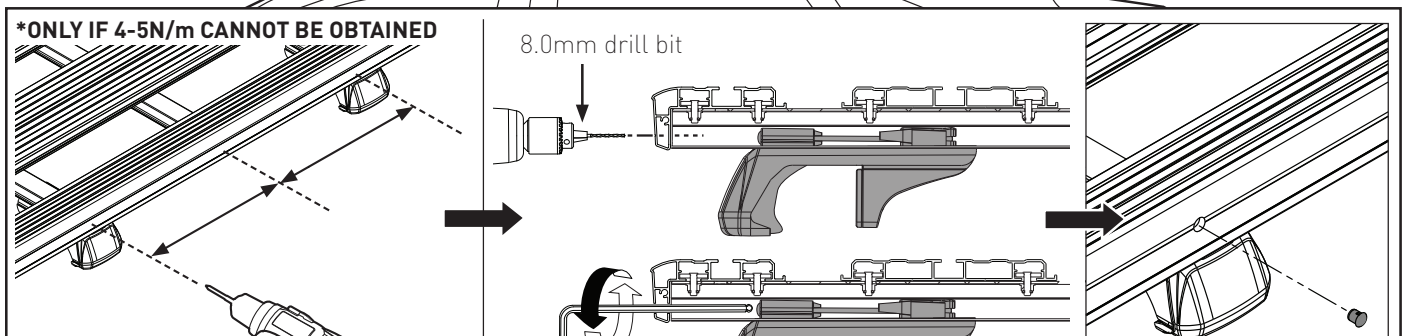
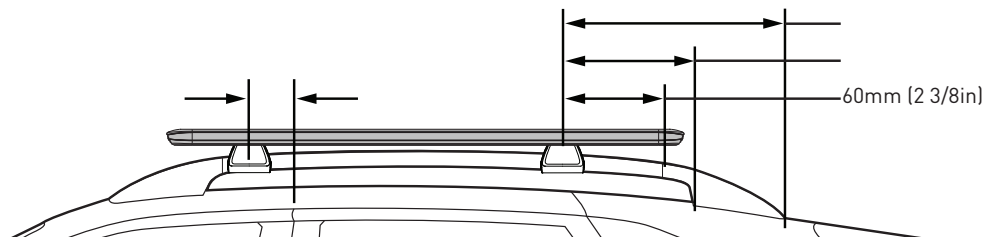

NOTES FOR DEALERS / FITTERS

It is your responsibility to ensure these fitting instructions are given to the end user or client.

Document No: R2089
Issue No: 5
Issue Date: 19-Mar-21