

VEHICLE				PIONEER	CONNECTOR	HEIGHT ADDED (mm/in)		
TOYOTA Land Cruiser Prado 150 Series 4WD/SUV Raised Rail 5 dr				52100	RX100			
VEHICLE NOTES	- Do not operate sunroof							
REGION	AUS	NZ	USA	CA	SA	UK	EU	ZA
AVAILABILITY	✓	✓	x	x	x	✓	✓	✓
RUNNING DATES	2009 -	2009 -	-	-	-	2009 -	2009 -	2009 -

VISIT THE ONLINE CALCULATOR FOR CURRENT SYSTEM LOAD LIMIT DATA



DYNAMIC LOAD LIMIT (ON AND OFF-ROAD):
 *USE THE VEHICLE MANUFACTURER'S MAXIMUM ROOF ALLOWANCE IF IT IS LOWER THAN THE FIGURE LISTED



 CARGO
 UP TO **81 Kg**
178 lbs

+



 SYSTEM WEIGHT
 UP TO **19 Kg**
42 lbs

=

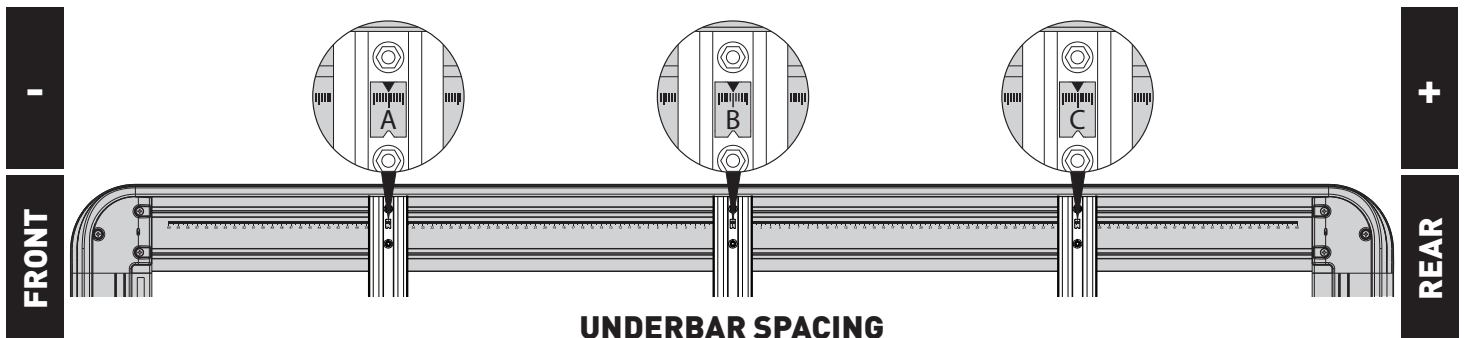

 LOAD LIMIT
 UP TO **100 Kg**
220 lbs

OR 
 *VEHICLE MANUFACTURER'S ROOF LOAD LIMIT



TOTAL STATIC LOAD LIMIT: UP TO 250 Kg / 551 lbs*

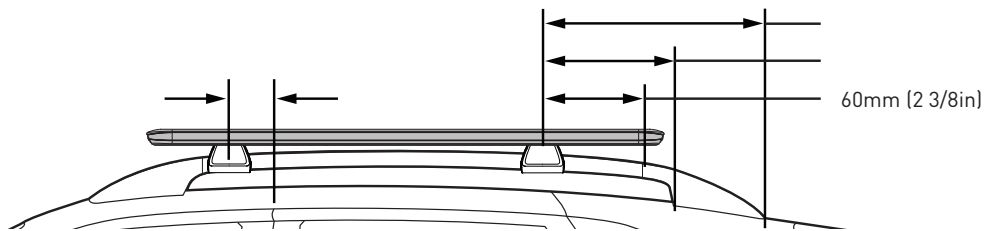

BAR NO.	A	B	C	D	E	F	G
DIMENSION (CM)	-42	0	43				
SPACERS REQ'D							
CONNECTOR	RX		RX				

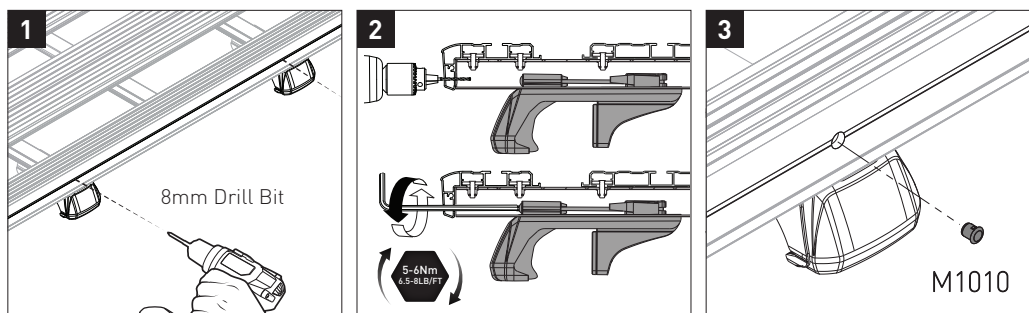

*ONLY IF 5-6N/m CANNOT BE OBTAINED



NOTES FOR DEALERS / FITTERS

It is your responsibility to ensure these fitting instructions are given to the end user or client.

Document No: R3153
 Issue No: 1
 Issue Date: 07-Feb-23