

VEHICLE	PIONEER SIZE	CONNECTOR	HEIGHT ADDED (mm / in)
VOLKSWAGEN Amarok 2H Pickup/Ute 4dr	52100	RVAB1	

<b>IMPORTANT NOTES</b>	Requires Kit SP308 Do not operate sunroof
------------------------	--

REGION	AUS	NZ	USA	CA	SA	UK	EU	ZA
AVAILABILITY	✓	✓	✗	✗	✗	✓	✓	✓
RUNNING DATES	02/11 -	02/11 -	-	-	-	2011 -	2011 -	2011 -

**UNDERBAR SPACING**

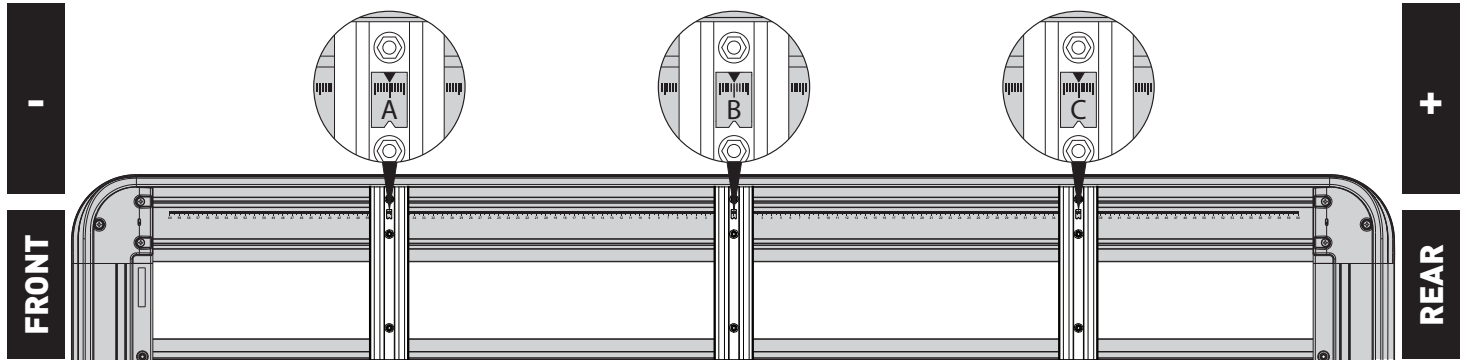

BAR NO.	A	B	C	D	E	F	G
DIMENSION (CM)	-54.5	0	52				
SPACERS REQ'D							
CONNECTOR	BACKBONE		BACKBONE				

VEHICLE LOAD LIMIT (VLL) (kg / lbs)	SYSTEM WEIGHT (SW) (kg / lbs)	ON-ROAD CARGO ALLOW. (OR)	OFF-ROAD CARGO ALLOW. (OFR)
Up to 100 / 220.5*	24 / 52.2	OR = VLL - SW	OFR = OR / 1.5

**\*CHECK YOUR VEHICLE OWNERS HAND BOOK FOR VEHICLE MAXIMUM CARRYING CAPACITY. PLEASE ENSURE YOU USE THE VEHICLE MANUFACTURERS MAXIMUM ROOF ALLOWANCE IF IT IS LOWER THAN THE FIGURE LISTED IN THIS INSTRUCTION.**

**NOTES FOR DEALERS / FITTERS**  
It is your responsibility to ensure these fitting instructions are given to the end user or client.

Document No: R1941  
Issue No: 2  
Issue Date: 18-Feb-20

These instructions remain the property of Rhino-Rack Australia Pty. Ltd. and may not be used or changed for any other purpose than intended.